



Operating Instructions

Versafreeze Freezer Cabinets

VF 15040, VF 60040, VF 70040, VF 15085, VF 60085, VF 70085



LAUDA-GFL Versafreeze Freezer Cabinets for the long-term storage of organic substances, for example, operate silently and with exceptional reliability. Insulation consisting of vacuum insulation panels and polyurethane foam is the key to its economical energy consumption.

The refrigeration compartment is made entirely of stainless steel.

The refrigeration system incorporates fully hermetic, air-cooled high-performance compressors and is maintenance-free.

Freezer cabinet models VF 15040, VF 60040, VF 70040 can be set to temperatures as low as -40 °C.

Freezer cabinet models VF 15085, VF 60085, VF 70085 can be set to a temperature between -50 °C and -85 °C, and offer the best temperature stability in relation to the set temperature.

Before installing the appliance, please check the content of the delivery for completeness and integrity.

If you discover damage or have any complaints, please get in touch with your supplier or contact us directly.

LAUDA-GFL Gesellschaft für Labortechnik mbH
Schulze-Delitzsch-Str. 4+5
30938 Burgwedel - Germany
Phone: +49 (0)5139 9958 0
Fax: +49 (0)5139 9958 21
E-mail: info@lauda-gfl.de
Internet: www.lauda.de/de/lauda-gfl

Table of contents

| | |
|---|-----------|
| Operating Instructions | 1 |
| 1 Using the freezer cabinets..... | 7 |
| 1.1 Intended use | 7 |
| 1.2 Improper use | 7 |
| 2 Warranty | 7 |
| 3 Before starting up..... | 7 |
| 4 Location of the freezer cabinet | 8 |
| 4.1 Under table installation (only applies for VF 15040 and VF 15085)..... | 9 |
| 5 Operating voltage and electrical connection | 10 |
| 6 Commissioning | 11 |
| 6.1 Operating and display elements on the touch screen unit..... | 12 |
| 6.2 Switching the appliance on and off..... | 14 |
| 6.3 Selecting a user profile | 14 |
| 6.4 Managing access rights for user profiles (login and user profile display) | 14 |
| 6.4.1 <i>Switching the appliance on and off.....</i> | 15 |
| 6.5 Language selection | 16 |
| 6.6 Refrigeration compartment temperature set point..... | 16 |
| 6.7 Changing the password | 17 |
| 7 Function description | 18 |
| 7.1 Function of data logger, history..... | 18 |
| 7.2 Data transfer via USB | 19 |
| 7.3 Internet connection..... | 19 |
| 7.3.1 <i>Entering e-mail addresses for forwarding alarms.....</i> | 19 |
| 7.3.2 <i>E-mail configuration.....</i> | 20 |
| 7.3.3 <i>Alarm management</i> | 20 |
| 7.4 Optional Water cooling..... | 21 |
| 7.4.1 <i>Setting the cooling water volume regulator.....</i> | 22 |
| 8 Alarm limit values | 23 |
| 8.1 Setting a limit value for the door alarm delay | 23 |
| 8.2 Overtemperature limit value..... | 23 |
| 8.3 Low temperature limit value..... | 23 |
| 8.4 USr User level | 23 |
| 8.5 Alarm and potential-free contact | 24 |
| 8.6 Resetting an alarm | 24 |
| 8.7 Probe monitoring..... | 24 |
| 8.8 Overtemperature or low temperature alarm..... | 24 |
| 8.9 Mains power failure..... | 24 |
| 8.10 Battery fault alarm (internal battery)..... | 24 |
| 9 Care and maintenance | 25 |
| 9.1 Defrosting..... | 25 |
| 9.2 Technical support..... | 25 |

| | | |
|-----------|--|-----------|
| 10 | Disposing of old appliances | 25 |
| 11 | Technical data | 26 |
| 12 | Circuit diagram..... | 28 |
| 13 | Spare parts list | 34 |
| 13.1 | Freezer cabinet VF 15040 / VF 15085..... | 34 |
| 13.2 | Freezer cabinet VF 60040, VF 60085 / VF 70040, VF 70085..... | 36 |
| 13.3 | Elektrical Switchgear | 38 |
| 14 | Auxiliary equipment..... | 39 |
| 14.1 | Data logger for monitoring and recording refrigeration compartment temperature | 39 |
| 14.2 | Storage system | 39 |
| 14.2.1 | <i>Racks with drawers</i> | <i>39</i> |
| 14.2.2 | <i>Racks with loading from the side.....</i> | <i>40</i> |
| 14.2.3 | <i>Boxes</i> | <i>40</i> |
| 14.2.4 | <i>Grid dividers</i> | <i>40</i> |
| 15 | Notes..... | 41 |

1 Using the freezer cabinets

1.1 Intended use

LAUDA Versafreeze Freezer Cabinets can be set to temperatures between 0 °C and –85 °C, depending on the version. The Freezer Cabinets are intended for the long-term storage of organic substances, for example.



In order to guarantee that the freezer cabinet functions perfectly, always read and observe the information in these operating instructions. Only persons familiar with these operating instructions are permitted to install and operate the appliances.



Caution:

Due to the low temperatures in the refrigeration compartment, suitable protective gloves must always be worn when storing and retrieving refrigerated goods. Arms must also be covered.

1.2 Improper use

LAUDA Versafreeze Freezer Cabinets are not suitable for the long-term storage of food and beverages, or similar products. The storage of highly flammable and/or explosive substances is forbidden.

The freezer cabinet must not be installed or operated in laboratory areas with aggressive or corrosive ambient conditions. Aggressive media such as hydrochloric acid may not be heated or evaporated in the immediate vicinity or inside the appliance itself. The freezer cabinet must not be operated in hazardous areas.

LAUDA Freezer Cabinets used in laboratories are not classified as medical devices. They are not subject to national or international medical device law and must be used accordingly.

2 Warranty

All laboratory equipment and accessories from LAUDA-GFL Gesellschaft für Labortechnik mbH are subject to warranty claims, including repairs, installation and spare parts. In order to identify faulty appliances, we need the type designation and the serial number from the type plate located at the top left of the right side wall of the freezer cabinet and possibly a copy of the invoice.

3 Before starting up

In order to guarantee that the freezer functions perfectly, always read and observe the information in these operating instructions. Safety instructions are identified by the following warning symbols.



Read and observe the operating instructions



Caution!
Flammable refrigerant
(hydrocarbons)



Warning of cold surfaces



Warning of dangerous electrical voltage



General hazard warning



Warning indicating crushing of hands

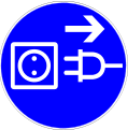

Disconnect all poles on the appliance from the power supply before commencing maintenance and repair work (pull the mains plug).

The warranty does not cover the free repair of malfunctions resulting from improper installation and handling.



Only trained and qualified personnel are permitted to perform service and repair work on refrigeration equipment. In the event of repair work, the refrigerant quantity must not exceed the initial fill quantity. See the type plate for quantity information and material specifications.

Before soldering work is carried out on the refrigeration system, the refrigerant must be drained completely and the system blown through with dry nitrogen. Only trained and qualified personnel are permitted to dispose of refrigerant and removed components.



Caution: flammable refrigerant (hydrocarbons)

Due to the nature and quantity of the refrigerants used, naked flames are prohibited within a radius of 1 m of the appliance.

Removed components bearing this marking must be disposed of separately.

4 Location of the freezer cabinet

Always install the appliance on a solid, flat, horizontal indoor surface. The installation room must be at least 24 m³ in size. Alternatively, the installation room must be ventilated. Freezer appliances must be positioned a minimum of 150 mm away from other appliances or walls so that the aspirated cooling air can circulate freely. The condenser on the back of the appliance must not be obstructed or blocked in.

The ambient temperature must not exceed +28 °C, as this would reduce the cooling capacity of the appliance and increase the temperature in the refrigeration compartment. Effective ventilation in the installation room is usually sufficient to lower the temperature.

The appliance is not intended for use in areas with an explosion hazard, such as during anesthesia using flammable gases or vapors. Please refer to the technical data for information on the appliance protection level.

4.1 Under table installation (Only applies for VF 15040 and VF 15085)

The cover panel on the deep-freeze appliance must be removed prior to installation under a tabletop. When the appliance door is open, you can reach the screw connection for the cover by inserting a Phillips screwdriver through the opening on the right side of the upper housing frame. After loosening the screw, pull the cover panel approx. 2 cm forward and then lift from the appliance.

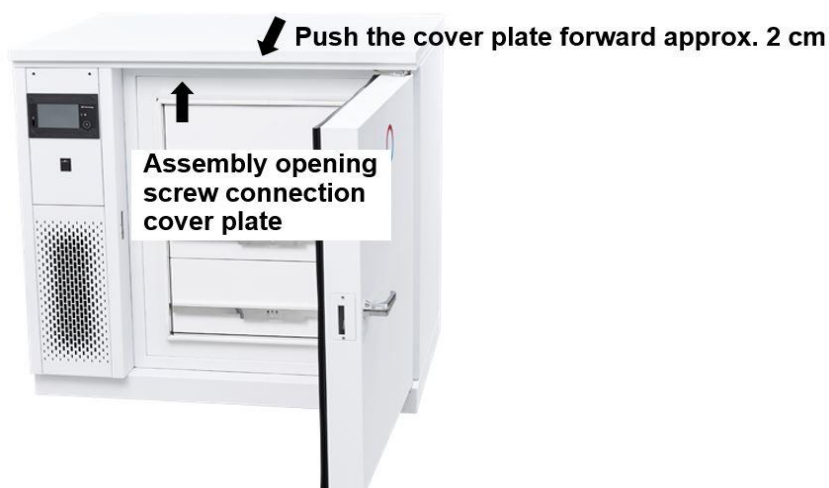

Please refer to the illustration below for the minimum dimensions for under table installation.

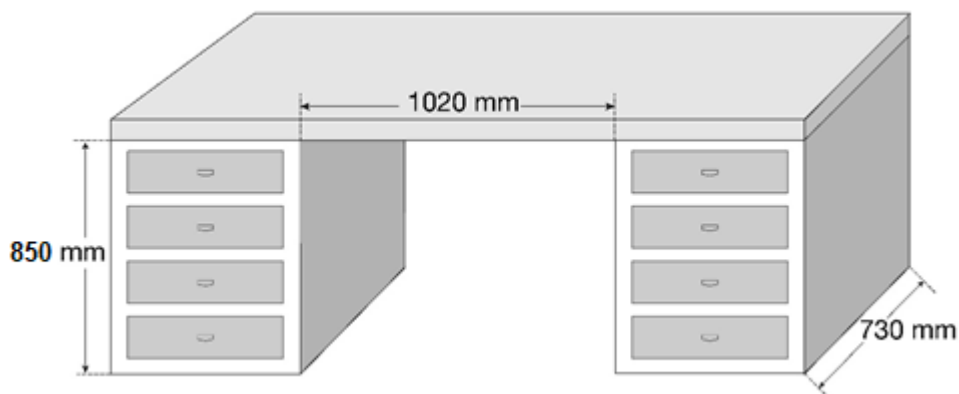

Before the appliance is moved to its place of installation, the electrical system (see point 5 of these instructions) and, if necessary, the alarm system (see point 8.5) must be connected. Ensure that the connection cable is not damaged when the freezer appliance is moved.

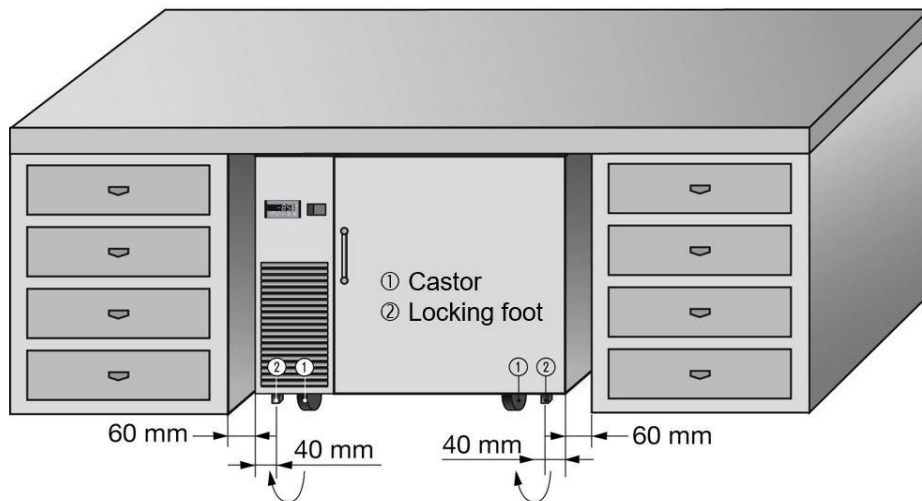

Freezer cabinets installed under tabletops must be positioned a minimum of 60 mm away from other appliances or walls so that the aspirated cooling air can circulate freely. Once the freezer cabinet has been moved to its place of installation, it must be secured in position with the locking feet^②. The locking feet are positioned at a distance of approx. 40 mm from the side walls under the front of the appliance. Use the wrench supplied to unscrew the feet by turning clockwise until they are resting securely on the ground. It should now no longer be possible to move the appliance on the casters^①.



Caution!

Due to the nature and quantity of the refrigerants used, naked flames are prohibited within a radius of 1 m of the appliance.

5 Operating voltage and electrical connection

A marked equipotential bonding connection is located on the back of the freezer cabinet. Local regulations may stipulate the need to connect the appliance to a grounding network for equipotential bonding. Please check before commissioning the appliance.

Off



The operating voltage and the mains frequency on the type plate (right side wall, top left) must match the power supply specifications.

The main switch on the refrigeration system must be switched off (position 0). Once these conditions have been met, establish the electrical connection.

On



The refrigeration system may only be operated on a correctly installed power connection with a protective earth conductor (PE) that complies with local regulations.

It must be possible to disconnect all poles of the power supply from the power network (e.g. via an earthed socket or switch).

6 Commissioning



Caution:

Due to the low temperatures in the refrigeration compartment, suitable protective gloves must always be worn when storing and retrieving refrigerated goods. Arms must also be covered.



Caution:

Do not leave the freezer cabinet keys near the appliance or within the reach of children.
Do not store acids and alkalis that can erode the materials, hazardous substances that emit harmful vapors, or highly flammable and/or explosive substances inside the appliance (DGUV Information 213-850).



Read and observe the operating instructions.

6.1 Operating and display elements on the touch screen unit

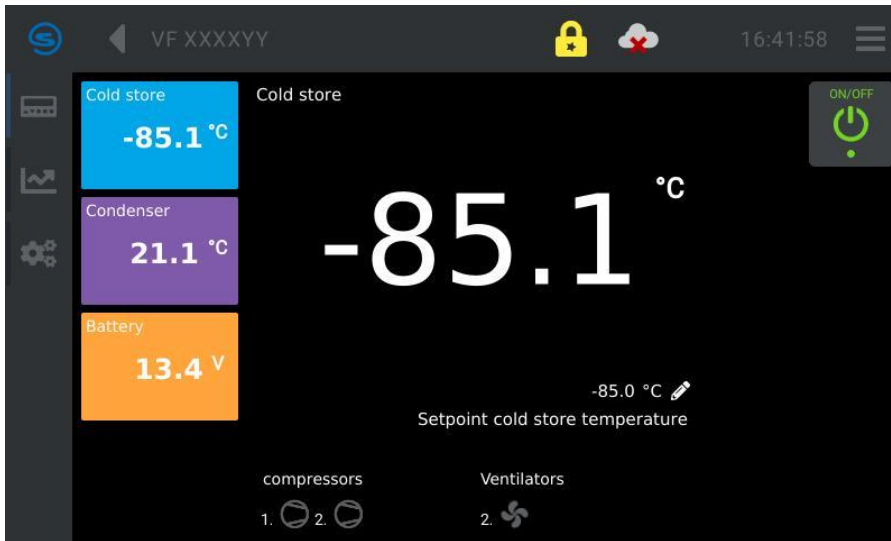

The three large colored symbols on the left of the display indicate the ACTUAL temperature at the most important points on the appliance: the refrigeration compartment (blue field) and condenser (purple field), while the orange field shows the voltage of the internal battery. The bottom line on the display indicates whether the appliance is a single-stage or dual-stage device. Rotating symbols indicate that the compressors or internal fan on the condenser are operating. The other symbols have the following meaning:

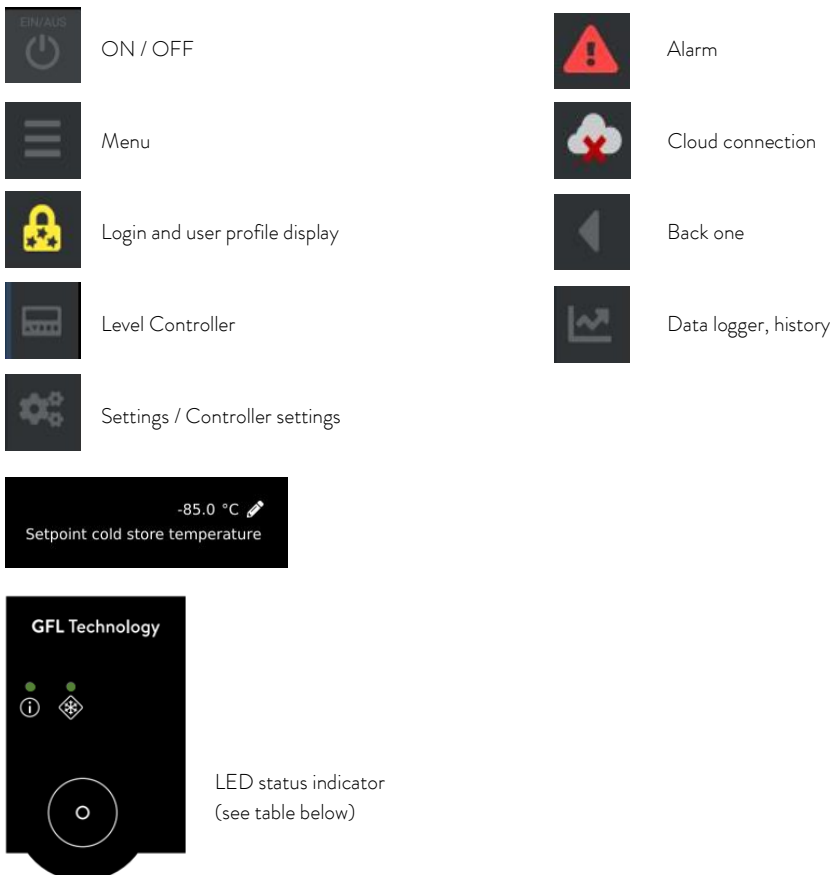

Normal refrigeration LED 1 and auxiliary device LED 2

| Status No. | LED 1 i symbol | Description |
|------------|---------------------------|---|
| 1 | green | active and no fault during normal refrigeration |
| 2 | red | All other cases, including: Connection failure Collective fault Standby |
| Status No. | LED 2 Snowflake symbol | Description |
| 1 | green | active and no fault in the auxiliary device |
| 2 | yellow | Refrigeration compartment temperature is too high. Safety cooling (auxiliary device) is on standby. Solenoid valve will be activated "soon" and no fault in the auxiliary device. "Soon" means: Refrigeration compartment temperature is within the hysteresis range around the resulting set point (between lower and upper switching point) and solenoid valve is not active. |
| 3 | yellow, flashing | Solenoid valve active (coolant (CO ₂ or LN ₂) is injected), no fault in the auxiliary device. Coolant is only injected when the door is closed. |
| 4 | off | No auxiliary device connected. |
| 5 | red | All other cases, including: Collective fault Standby |

6.2 Switching the appliance on and off

The appliance can only be switched on and off from the user profile "User"  (see points 6.3 and 6.4 in the operating instructions). Switch on the appliance by setting the main switch (see point 5 of the operating instructions) to position "I". Approx. 5 seconds after the control element has booted up, the overtemperature T_{max} 1 alarm appears on the display and the alarm signal sounds. Acknowledge the alarm on the display.

6.3 Selecting a user profile

To select a user profile such as User (point 6.4 of the operating instructions), tap the "Login" symbol  and user profile display. Tap the desired user profile to select it, enter the relevant password for the selected profile (point 6.4. of the operating instructions) and press save to exit the screen.

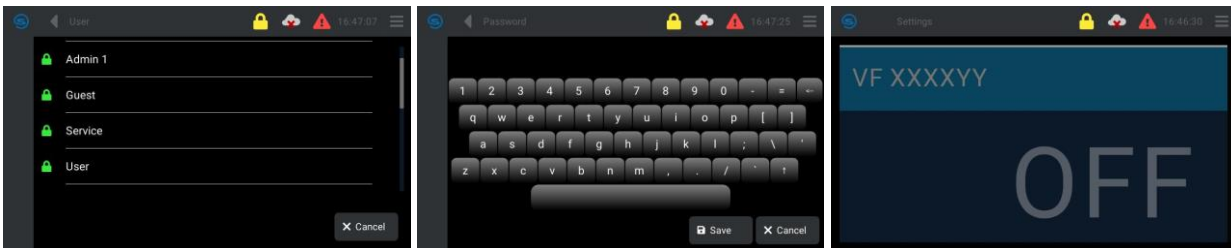

6.4 Managing access rights for user profiles (login and user profile display)



Admin 1

All settings required to integrate the freezer into the operator's IT landscape, for example, can be configured under the user ID Admin1. The default password is "Admin 1".



Guest

The freezer appliance is started under the user ID "Guest". All relevant operational data can be accessed on this level. It is not possible to switch the appliance on and off or modify settings on this level. The default password is "Guest".



User

Users logged in to the "User" profile can configure settings such as those for switching the appliance on and off as well as the refrigeration compartment temperature set point and the alarm delay for the door. The default password is "User".



Service

Under the "Service" user ID, the operator/user can modify more advanced settings than those on the "User" level, including changing parameters or set point temperature limits and transferring data via USB. The default password is "Service".

ADMIN

All data and settings that were preset by the manufacturer of the freezer appliance, such as the permitted or possible set point limits for the refrigeration compartment temperature, are stored under the "ADMIN" user profile. The operator cannot modify the settings in this profile.

6.4.1 Switching the appliance on and off

Once the user profile has been changed, the display switches to the start screen. Touch VF XXXYY on the display to switch to the controller view. Press the ON/OFF symbol  on the touch screen unit. The temperature and "collective alarm" appear on the display. Acknowledge the alarm.

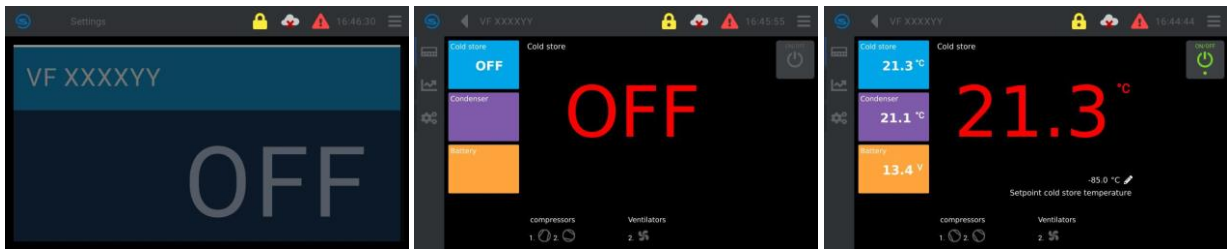

To switch off the appliance, first press the ON/OFF symbol  on the touch screen unit and then set the main switch to position 0.



Caution:

To switch off the freezer cabinet for longer periods, press the ON/OFF symbol on the touch screen unit until OFF appears on the display and then set the main switch to position 0.

If the alarm contact of the alarm system (see point 7 of the operating instructions) is connected to an in-house fault monitoring system, an alarm is triggered when the cabinet is switched off.

Inform the office responsible for monitoring faults well in advance that you intend to switch off the freezer cabinet.



Caution:

If the appliance is only switched off at the main switch, the "power failure" alarm triggers and the appliance records the temperature inside the cabinet for approx. 35 hours, powered by the internal battery.

6.5 Language selection

The only languages currently available are German and English
Proceed as follows:

Menu
Settings
Language

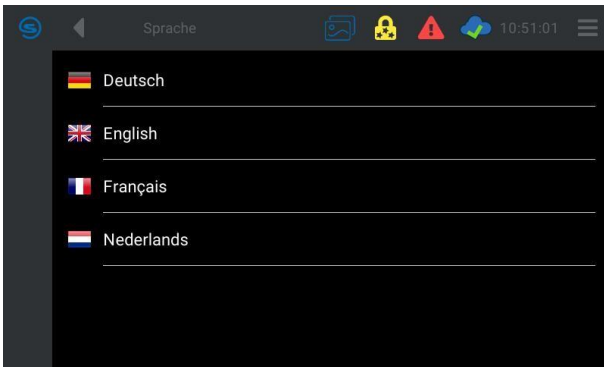

After selecting the language, press the  switch below the additional LED display. Touch VF XXXYY on the display to switch to the controller view.

6.6 Refrigeration compartment temperature set point

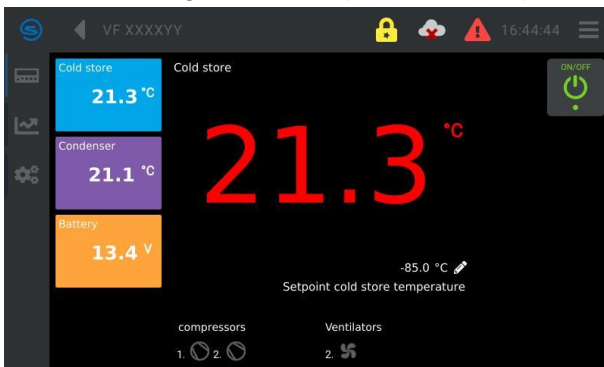

Once the refrigeration device has been switched on at the main switch and the touch screen unit (see above), the display shows the current temperature in the refrigeration compartment. The temperature controller switches on the compressors to start the cooling process so that the refrigeration compartment reaches the set point temperature. The refrigeration compartment temperature display remains red until the set point temperature is reached. When the set point is reached, the display color changes to white. If a fault occurs on the appliance, the display changes back to red.

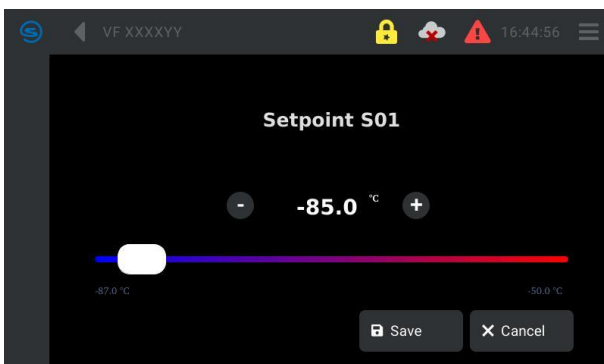

The refrigeration compartment temperature set point can be modified by tapping the symbol for the refrigeration compartment temperature set point. Select the required temperature in the refrigeration compartment by sliding the cursor or pressing the "-" or "+" symbol, and then press the save button to store the refrigeration compartment temperature set point.

6.7 Changing the password

Only the passwords for a specific user profile and all subordinate levels can be changed from the relevant user profile. An Admin1 can change all passwords, a User can only change the passwords for a subordinate Guest. The number of stars in the yellow padlock at the top of the screen indicates which user profile is currently active.

The Admin1 padlock contains three stars, Service two stars, User one star, and Guest no stars. Tap the menu symbol to change the password for a user profile.

Menu

User management

User

Then tap user management and select the relevant user. Tap the input symbol , enter the "old password" and save. The display changes to "Password". Enter and save the new password, then touch the symbol for one level back twice to display the controller view.

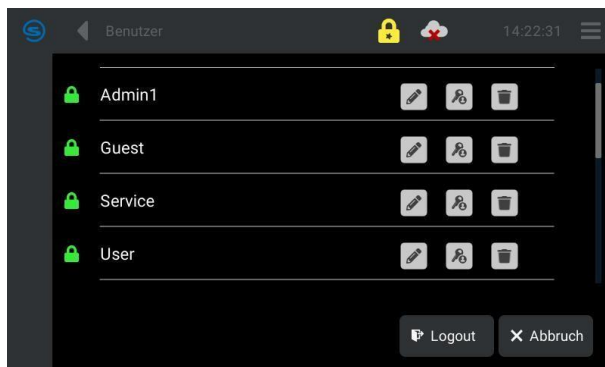

7 Function description

LAUDA Versafreeze freezer cabinet models VF 15040, 60040 and 70040 are equipped with a high-performance compressor and operate within a variable temperature range of -0°C to -40°C . Models VF 15085, 60085, and 70085 are equipped with two high-performance compressors and operate at a temperature range of -50°C to -85°C . The air-cooled condenser on the back of the appliance releases heat extracted from the refrigeration compartment into the room. The temperature controller maintains a constant temperature in line with the preset value. The current temperature in the refrigeration compartment is shown on the controller display.

7.1 Function of data logger, history

The data logger starts automatically and records the temperature in the refrigeration compartment, the condenser temperature, and the internal battery voltage every 120 seconds. Different views, e.g. days or hours, can be selected by tapping the "Data logger, history" symbol.

To view past events, tap the  symbol to open a window for setting the start and end dates. Now choose the desired start and end dates, tap to select, then press OK to confirm. Tap an hour or day to return to the current display. The data logger is fitted with a 1 GB industrial SD card and can therefore record data for 2 years before the memory is full. When the memory is full, the oldest data is overwritten first so that only the most recent data is retained. We recommend exporting the data, e.g. every six months, depending on its importance, or performing more regular backups (see Data transfer via USB).

Selection of displayed control curves:

Briefly tapping the symbols An1, A2F, or ba1 shows the designation of the symbols on the left of the display.

All three control curves are selected by default. In order to display only one control curve, the other control curves must be deactivated. To deactivate a control curve, press the corresponding symbol and hold for approx. 3 seconds. The symbol turns white and the control curve disappears. To activate the control curve, press the deactivated white symbol and hold for approx. 3 seconds until it reverts back to its original color.

Blue (An1) = Refrigeration compartment (compartment temperature)

Purple (A2F) = Condenser (condenser temperature)

Orange (ba1) = Battery (internal battery voltage)

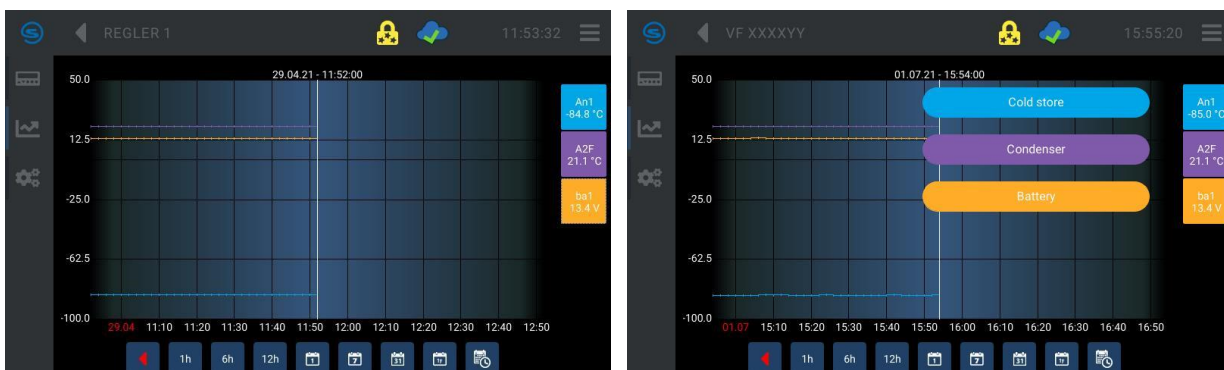

7.2 Data transfer via USB

In order to carry out a data transfer, the Service or Admin1 user profile must be selected. Proceed as follows:

Select Menu

Select USB

Select Export history

Insert USB stick. After the USB stick has been recognized, tap the save symbol.

After transferring the data, save and remove the USB stick

7.3 Internet connection

The touch control unit can also send alarms by e-mail. Different e-mail addresses and an e-mail server can be configured for this purpose.

7.3.1 Entering e-mail addresses for forwarding alarms

In order to configure e-mail addresses, the Admin 1 user profile must be selected. E-mail configuration is used to forward alarms via e-mail.

Pressing the:

Menu

E-mail configuration

Address book

Buttons opens the address book clicking the "Add" symbol opens the recipient window, where you can enter the name and e-mail address of the individuals who should receive e-mail notification of an alarm. Click Save to add the recipient.

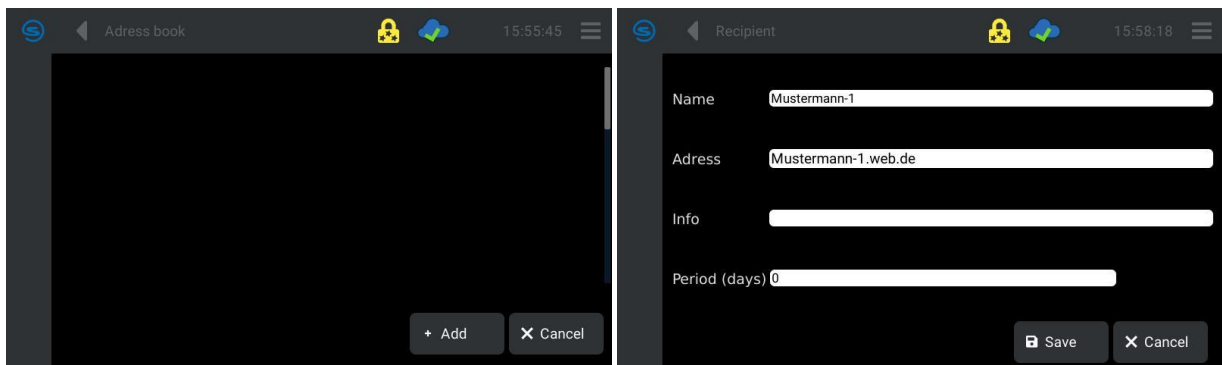

7.3.2 E-mail configuration

Pressing the:

Menu

E-mail configuration

E-mail server

buttons opens a window for configuring your e-mail server settings. Save your entries before exiting.

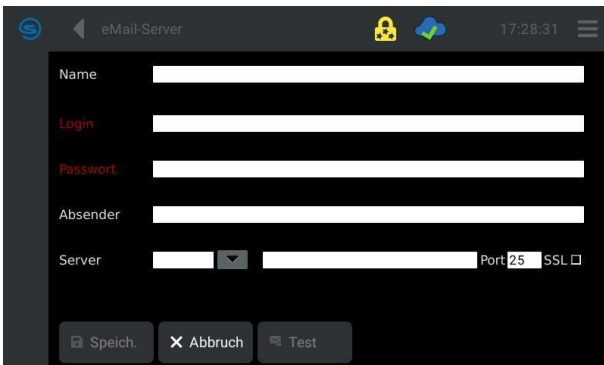

7.3.3 Alarm management

Since all alarms indicating a possible fault may impact the proper operation of the appliance, we always recommend selecting Alarm 1 or Alarm 2 rather than the Warning setting.



Pressing the:

Menu

Alarm management

Alarm 1

buttons opens the alarm management settings. Tapping the "Add" button opens the Controller window. Select the checkbox next to VFXXXXYY in this window and then save. The New configuration window then opens, where you can select individual alarms or

tap the  symbol to select all alarms. To give the configuration a name, tap the  symbol, enter the name, and save. A window with the name you assigned then opens. Tapping the "E-mail" button opens the Recipient window. Tap the white button next to the name in this window. A selection window containing the previously entered e-mail addresses opens. Select the required e-mail address and save. Press the  symbol to return to the screen view.

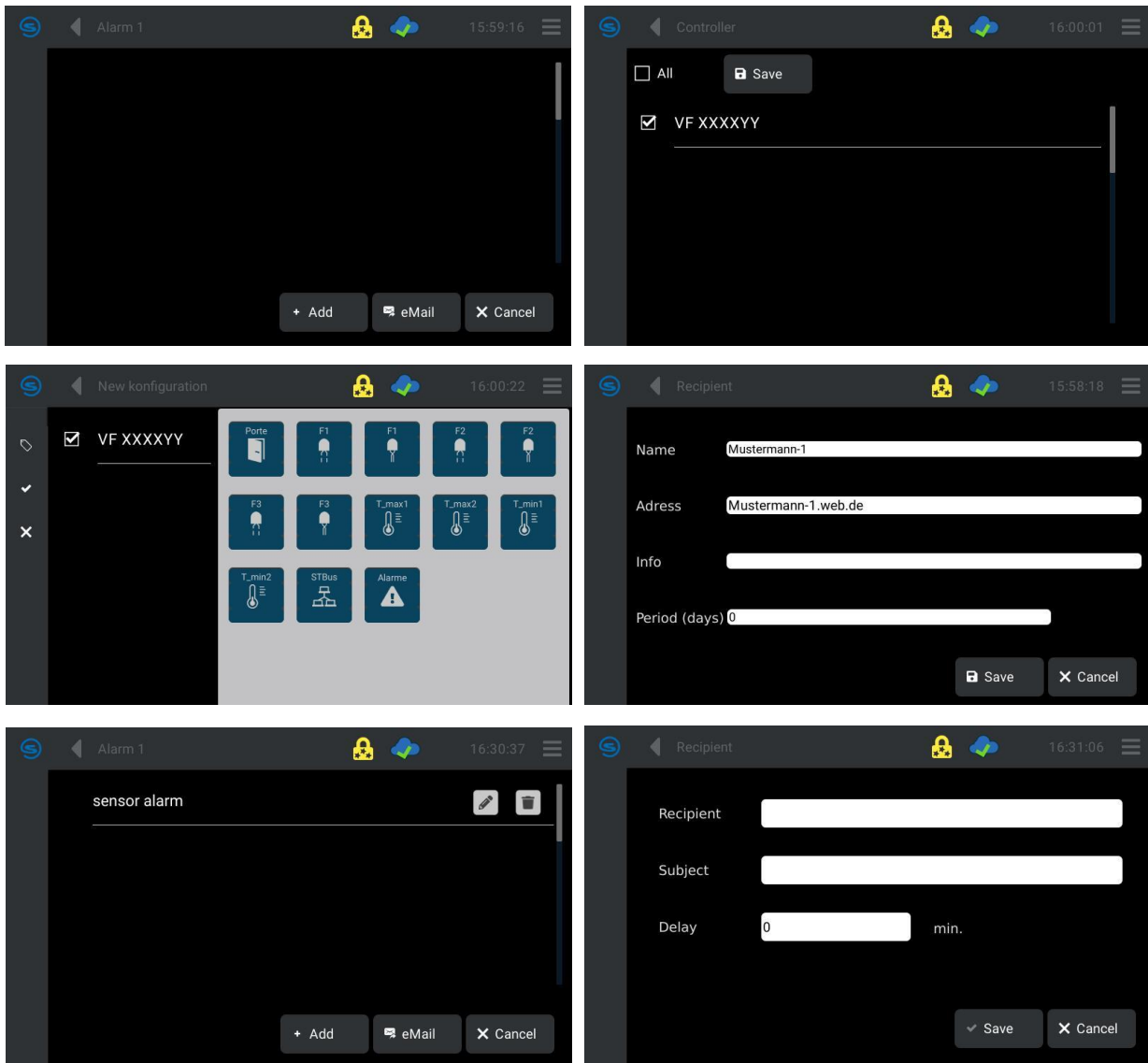

7.4 Optional Water cooling

Installation of a heat exchanger (water cooling agent) instead of the condenser. The heat exchanger reduces the heat emission of the unit to the ambient considerably and extends the permissible operating temperature range. The regulation is pressure-controlled by the Freezer. Suitable for connection to a recooling system or to water supply (connections with screw thread for pressure hose 1/2" with lock nut). Other connections on request.

Not available for models VF 150xx and VF 200xx C.

Inlet water pressure: min 0.2 bar, max 10 bar.

Inlet water temperature: min 4° C, max approx. 25° C.

7.4.1 Setting the cooling water volume regulator

The setting of the cooling water volume regulator is only necessary if the in-house cooling water is significantly warmer or colder than it was set in test mode. The value of the cooling water volume regulator set in test mode can be found on the label on the cover of the cooling water volume regulator. We recommend adjusting the cooling water quantity in small steps (approx. 0.1 on the scale) from a cooling water deviation of 10 °C. The temperature difference between the cooling water inlet and cooling water outlet temperature should be 15 - 20 K. To set the cooling water volume regulator, the cover of the cooling water volume regulator is on the back of the device.



Fig. 1
Unscrew the knurled screw and remove the cover.



Fig. 2
Open cover of the cooling water volume regulator.



Fig. 3
Turning the dial in direction 1 on the scale increases the amount of cooling water and turning it in direction 5 on the scale reduces the amount of cooling water.

8 Alarm limit values

8.1 Setting a limit value for the door alarm delay

Tap the Menu symbol on the touch screen unit. In the parameter level, scroll down to the USr user level, tap parameter A6, set the required limit value, and save. A timer starts when the door is opened. If the timer exceeds the preset delay time, the door alarm is triggered.

8.2 Overtemperature limit value

Tap the Menu symbol on the touch screen unit. In the parameter level, scroll down to the USr user level, tap parameter A13, set the required limit value, and save. If the refrigeration compartment temperature exceeds the upper preset limit value, the overtemperature alarm triggers.

8.3 Low temperature limit value

Tap the Menu symbol on the touch screen unit. In the parameter level, scroll down to the USr user level, tap parameter A15, set the required limit value, and save. If the refrigeration compartment temperature falls below the lower preset limit value, the low temperature alarm triggers.

8.4 USr User level

| | | | |
|------|--|-----------------|--|
| A 6 | = Alarm delay (door open) | Factory setting | 60 sec. |
| A 13 | = Lower limit 1 (abs/rel) | Factory setting | -4.0 K |
| A 15 | = Upper limit 1 (abs/rel) | Factory setting | 4.0 K |
| C 11 | = Refrigeration compartment temperature set point | Factory setting | The value is stored on the device card |
| C 25 | = Hysteresis sensor F1 | Factory setting | The value is stored on the device card |
| H 11 | = Offset correction sensor F1 | Factory setting | The value is stored on the device card |

The device card is located behind the right side cover of the machine compartment of the VF 600 ... and VF 700 ... and behind the left cover of the VF 150...

8.5 Alarm and potential-free contact

When a malfunction occurs, an alarm is triggered. Each alarm is issued in the form of an acoustic alarm signal and a visual alarm display. All triggered alarms are stored in the controller.

When an acoustic alarm signal is issued, the potential-free alarm contact simultaneously connects to the in-house fault monitoring system. The connection is located in the control cabinet behind the detachable lower right side panel and marked with a sticker. The maximum contact load is 230 V/1.5 A.

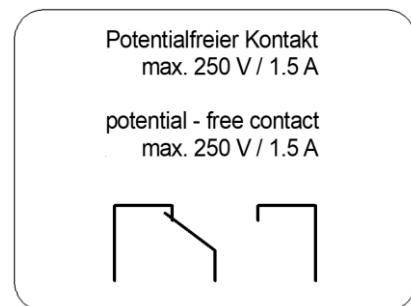

8.6 Resetting an alarm

When a malfunction occurs, an alarm is triggered. Each alarm is issued acoustically in the form of an alarm signal and displayed visually in an alarm window. Pressing the acknowledgment symbol in the alarm window switches off the acoustic alarm. The alarm screen closes and a red alarm symbol appears at the top of the touch screen unit. The alarm symbol disappears automatically once the cause of the alarm has been rectified.

8.7 Probe monitoring

The temperature probe on the controller is monitored continuously for short circuits and disruptions. If a fault occurs, corresponding information appears on the display in plain text. At the same time, an acoustic warning signal sounds (1 second on - 1 second off) and the potential-free alarm contact is switched over. If a probe is faulty, the emergency program starts. The freezer cabinet cools for 30 minutes (compressors operating) and then pauses for 10 minutes. Then the process is repeated. Note: while the emergency program is running, the temperature may deviate from the preset refrigeration compartment temperature.

8.8 Overtemperature or low temperature alarm

If the refrigeration compartment temperature exceeds the preset upper or lower temperature limit (as described in section 7.1), corresponding information appears in plain text on the display and an acoustic alarm sounds (1 second on - 1 second off). The potential-free contact is switched over.

8.9 Mains power failure

In the event of a mains power failure, an acoustic warning signal sounds (1 second on - 1 second off) and the potential-free alarm contact is switched over. The permanently integrated battery keeps the display and data logger (for data recording) functioning for approx. 35 hours in the event of a power failure.

8.10 Battery fault alarm (internal battery)

If the internal battery develops a fault, corresponding information is shown in plain text on the display, alternating with the current temperature. An acoustic alarm sounds (1 second on - 1 second off). The potential-free contact is switched over. Statutory provisions must always be observed when disposing of a faulty battery.

9 Care and maintenance

LAUDA-GFL Versafreeze laboratory freezer appliances are manufactured and engineered using the best materials. Powder-coated surfaces can be cleaned with mild cleaning agents, if necessary. We recommend applying talcum powder to the gaskets on the door and refrigeration compartment every now and then. In order to keep the cooling capacity constant, the condenser fins on the back of the appliance must be kept free of dust using a hand brush or vacuum cleaner.

Disconnect the appliance from the mains power supply before starting any repair or cleaning work. Be sure to read the information under point 5 of these operating instructions in relation to this.



Make sure that liquid cannot enter the cable connections or electrical equipment.
Risk of electric shock!

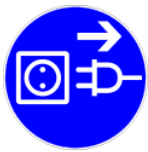

Disconnect the appliance from the mains power supply before starting any repair or cleaning work. Be sure to read the information under point 5 of these operating instructions in relation to this.

9.1 Defrosting

The refrigeration compartment must be defrosted if large volumes of ice begin to accumulate. Do not attempt to knock or scrape off the ice with a sharp object as this may damage the appliance. Leave the ice to thaw naturally. Placing heating devices inside the refrigeration compartment is not permitted, because it may cause technical defects.

Switch off the appliance as described in section 6.2 and disconnect the mains plug from the socket. Open the outer and inner doors and leave the ice to thaw. Remove the melt water regularly to prevent it from overflowing into the machine compartment. Then dry and clean the refrigeration compartment.

The appliance may only be reconnected to the power supply and switched on (section 6.2) when the refrigeration compartment is ice-free and dry.

9.2 Technical support

You can call our customer service at any time for technical support relating to LAUDA-GFL freezer appliances.

Phone +49 (0) 5139 9958-0

Fax +49 (0) 5139 9958-21

E-mail service@lauda.de

Maintenance, repairs and modifications must be carried out by a qualified electrician

(§2, Paragraph 3, DGUV Regulation 3) according to the General Rules of Technology

(§2, Paragraph 2, DGUV Regulation 3). Only original spare parts may be used. Request that the person performing the work provides written confirmation of the type and scope of the work carried out (company, date and signature).

10 Disposing of old appliances

As stipulated in legal guidelines, LAUDA-GFL assumes responsibility for the environmentally responsible return and disposal of all old appliances manufactured by our company on or after 1995 and delivered to us free of charge. Any old appliances received will be sent for recycling. Before sending any appliances, the owner must submit a legally binding declaration that the appliance is free of harmful contamination and hazardous substances resulting from its use.

LAUDA-GFL laboratory equipment is intended exclusively for commercial use and must not be disposed of via public disposal facilities.

EAR registration number WEEE-ID.NO.DE 67770231

11 Technical data

| | | |
|--|---|---|
| External dimensions (W x D x H in mm) | VF 15040 / 85 VF 60040 / 85 VF 70040 / 85 | 904 mm x 776 mm x 865 mm 990 mm x 1035 mm x 1965 mm 990 mm x 1185 mm x 1965 mm |
| External dimensions W (W x D x H in mm) Smallest external dimension z. B. after removal of the lock, the cable connection, the screw connections of the safety cooling or after removing the cover plate. | VF 15040 / 85 VF 60040 / 85 VF 70040 / 85 | 904 mm x 776 mm x 845 mm 915 mm x 950 mm x 1965 mm 915 mm x 1100 mm x 1965 mm |
| Internal dimensions and refrigeration compartment volume (W x D x H in mm) | VF 15040 / 85 VF 60040 / 85 VF 70040 / 85 | 480 mm x 480 mm x 560 mm 129 liters 738 mm x 600 mm x 1320 mm 584 liters 738 mm x 750 mm x 1320 mm 730 liters |
| Weight | VF 15040 / 85 VF 60040 / 85 VF 70040 / 85 | 145 kg / 165 kg 325 kg / 350 kg 350 kg / 375 kg |
| Maximum payload per floor or shelf with even distribution | VF 60085 VF 70085 | Standard 40 kg |
| Maximum payload per drawer (optional) with even distribution | VF 15085 VF 60085 VF 70085 | 12 kg 15 kg 15 kg |
| Minimum load carrying capacity of the floor at the appliance installation site | VF 15085 VF 60085 VF 70085 | ca. 70 N / cm ² / 80 N / cm ² ca. 159 N / cm ² / 179 N / cm ² ca. 170 N / cm ² / 190 N / cm ² |
| Temperature control | | Single-board controller |
| Temperature range | VF 15040 / 85 VF 60040 / 85 VF 70040 / 85 | 0 °C to -40 °C / -50 °C to -85 °C |
| Temperature stability (over time) | VF 15040 / 85 VF 60040 / 85 VF 70040 / 85 | +/- 1,5 °C at -40 °C / -85 °C |
| Temperature setting and temperature display | | Touch display |
| Electrical connection | | 230 V / +/- 10 % / 50 Hz |
| Mains fuse in building | | 16 A mT |
| Mains connection | | Safety plug |
| Protection level/protection class | | IP21 / I |
| Power consumption | VF 15040 / 85 VF 60040 / 85 VF 70040 / 85 | 0,5 kW / 1,0 kW 1,2 kW / 2,0 kW 1,2 kW / 2,0 kW |

| | | | |
|---------------------------------|---------------|---------------------------------------|---------------|
| Refrigerant quantity, 1st stage | Air cooling | VF 15040 | R1270 - 145 g |
| | | VF 60040 | R1270 - 145 g |
| | | VF 70040 | R1270 - 145 g |
| | | VF 15085 | R290 - 135 g |
| | | VF 60085 | R290 - 145 g |
| | | VF 70085 | R290 - 145 g |
| | Water cooling | VF 15040 | R1270 - 135 g |
| | | VF 60040 | R1270 - 145 g |
| | | VF 70040 | R1270 - 145 g |
| | | VF 15085 | R290 - 135 g |
| | | VF 60085 | R290 - 135 g |
| | | VF 70085 | R290 - 135 g |
| Refrigerant quantity, 2nd stage | VF 15085 | R170 - 50 g | |
| | VF 60085 | R170 - 90 g | |
| | VF 70085 | R170 - 96 g | |
| Ambient conditions | | Only used inside buildings | |
| | | Not in areas with an explosion hazard | |
| Ambient temperature | | 16 °C - 28 °C | |

12 Circuit diagram

| | |
|----|-----------------------------------|
| A1 | Single-board cryostat |
| A2 | Touch screen unit |
| F3 | Over pressure switch, 1st stage |
| F4 | Over pressure switch, 2nd stage |
| F5 | Microfuse 1.6 A T |
| F6 | Microfuse 1.6 A T |
| S1 | Mains switch |
| K1 | Main contactor |
| K2 | Potential-free contact |
| M1 | Compressor, 1st stage |
| M2 | Compressor, 2nd stage |
| M3 | Fan motor, 1,000 rpm or 1,500 rpm |

| | |
|----|---|
| | Single-board cryostat A1 |
| F1 | Temperature probe PT100 for refrigeration compartment |
| F2 | Temperature probe PT100 for condenser |
| E1 | Door switch/cover switch |
| S2 | Switch CO2/LN2 |
| S1 | Solid state relay, 1st stage 0/+15V max |
| S2 | Solid state relay, 2nd stage 0/+15V max |
| K3 | Potential-free contact |

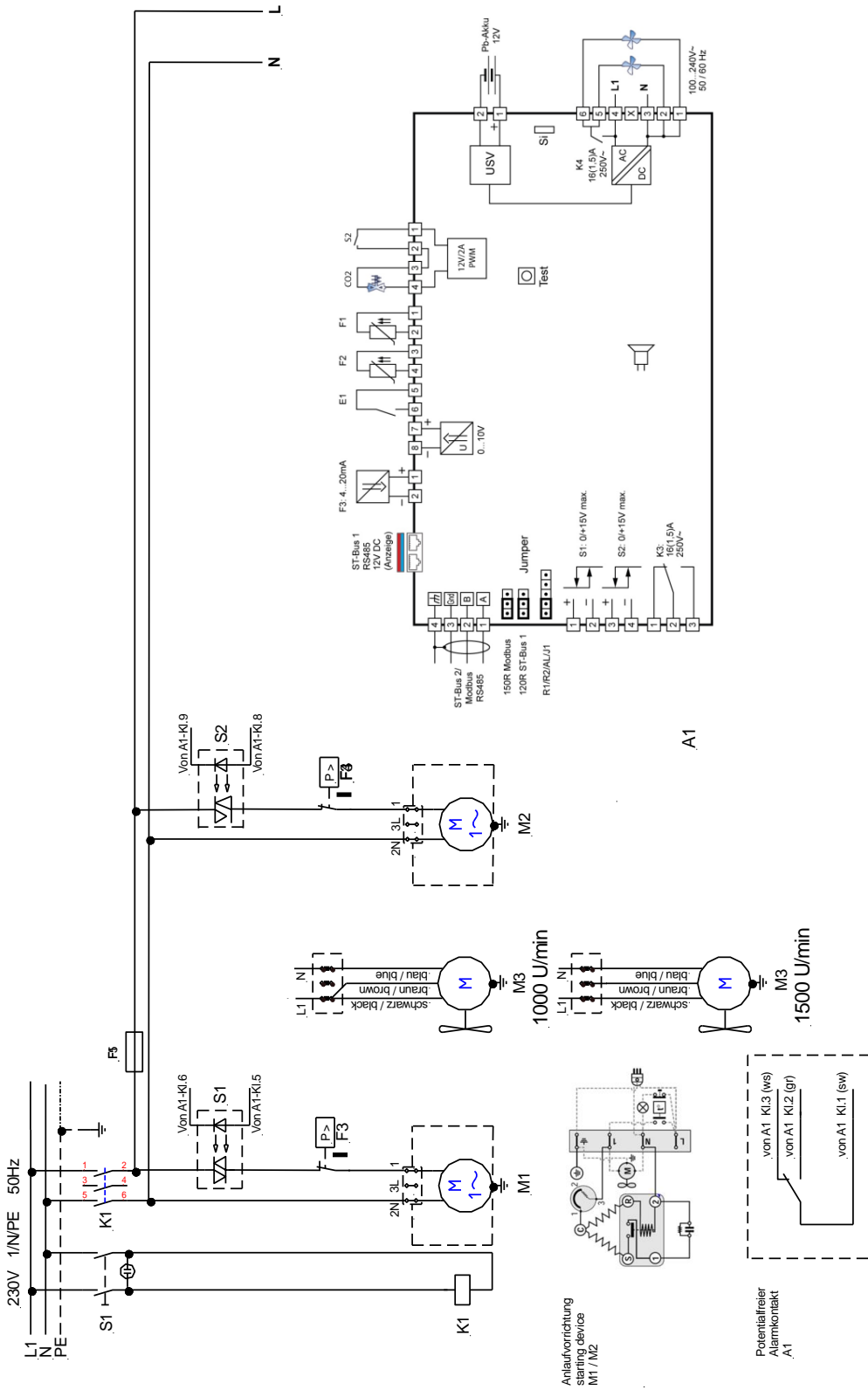

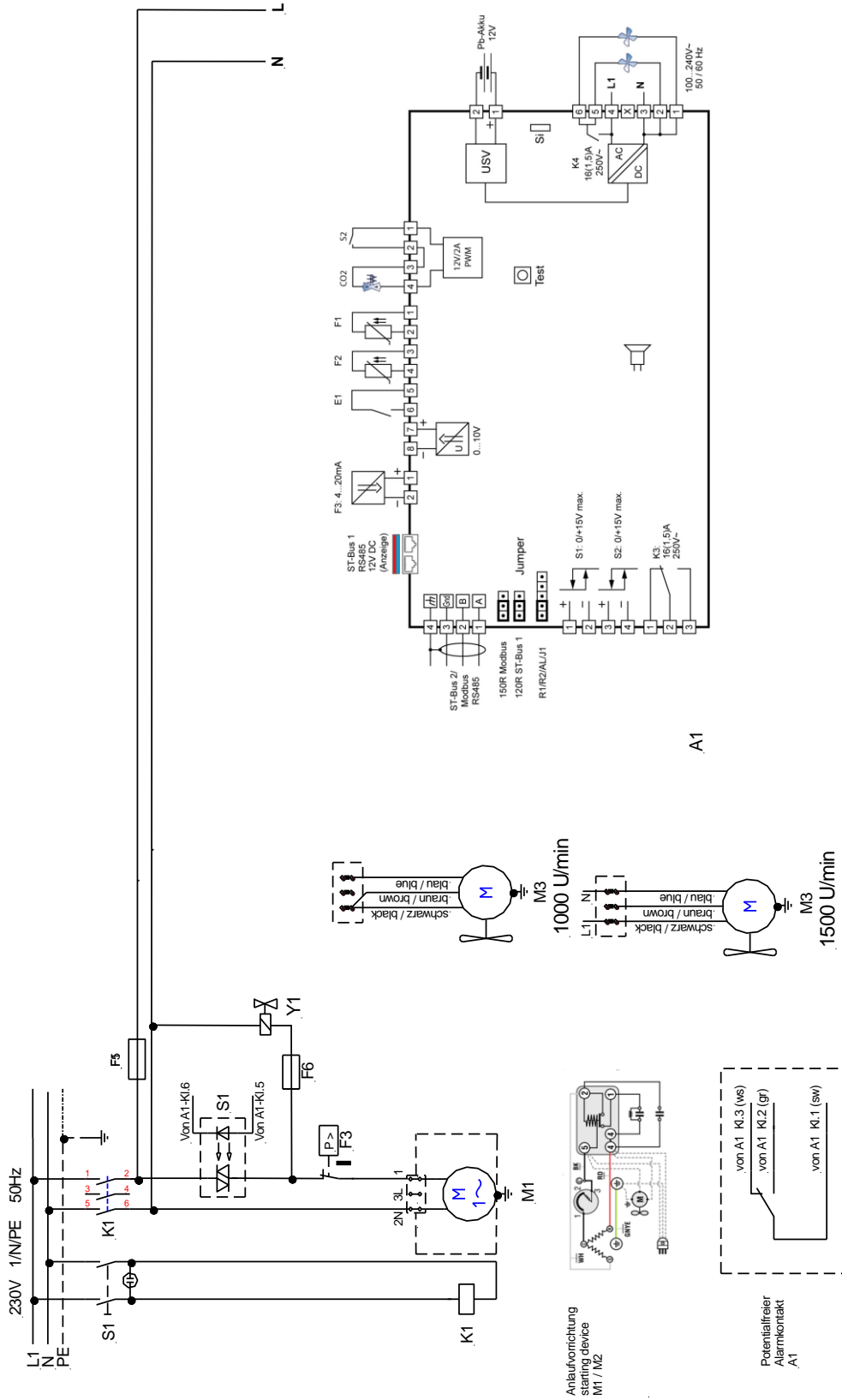

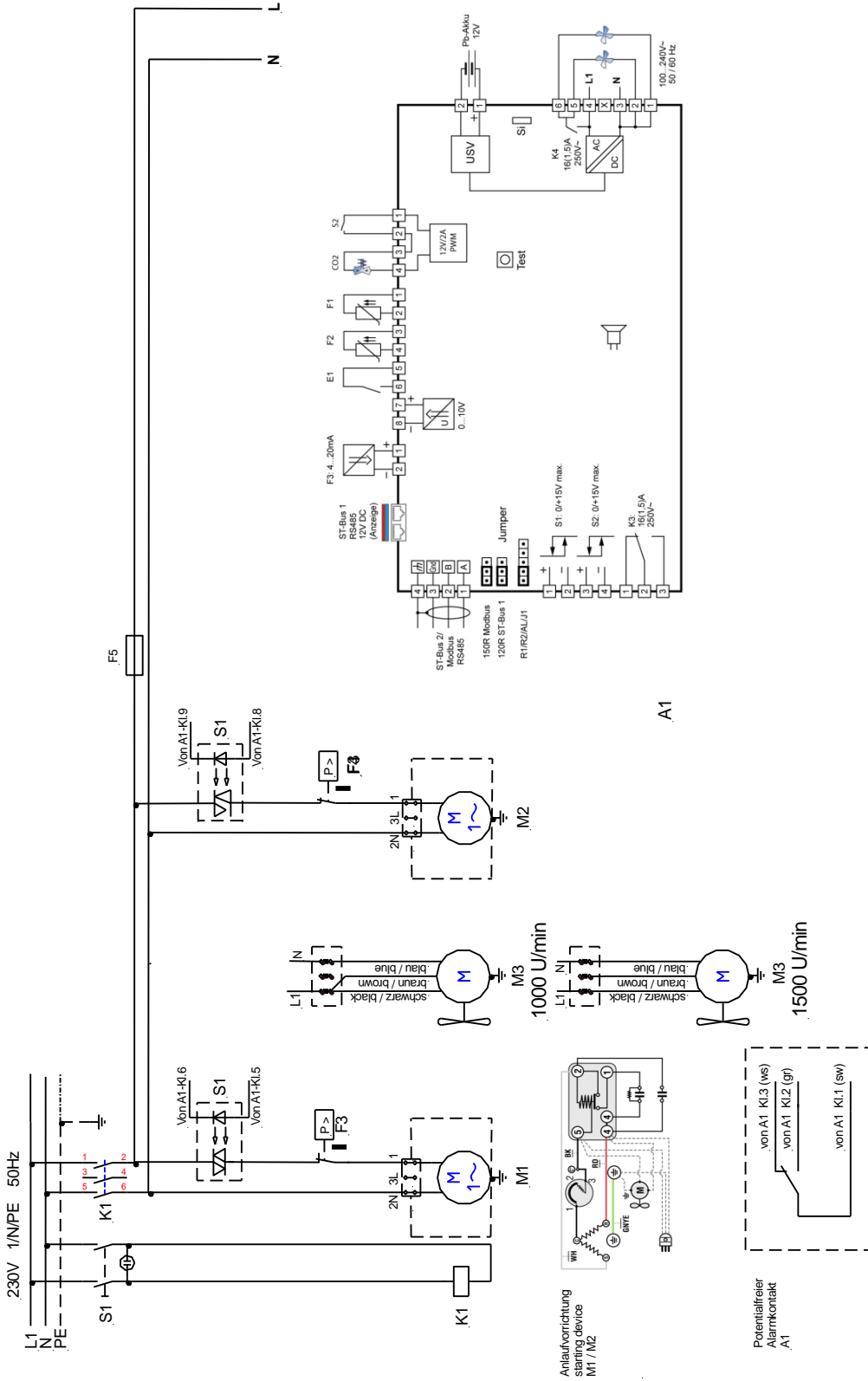

Touch screen unit

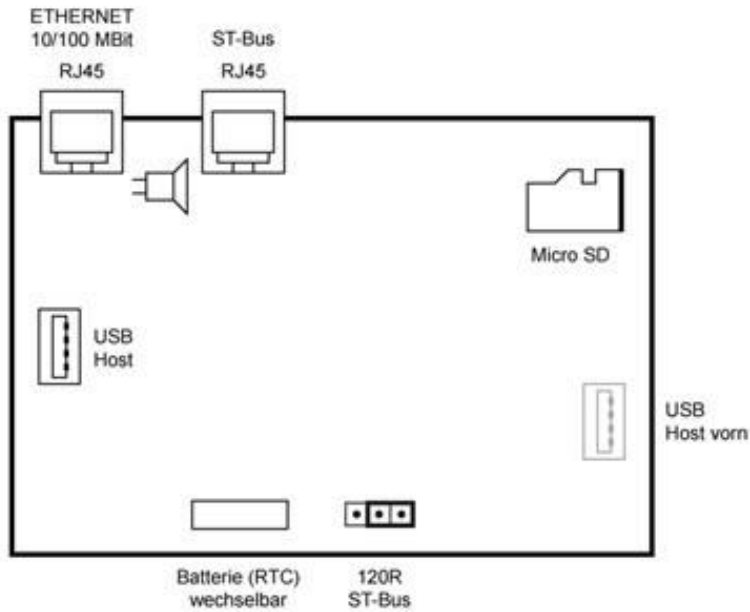

Single-board cryostat A1

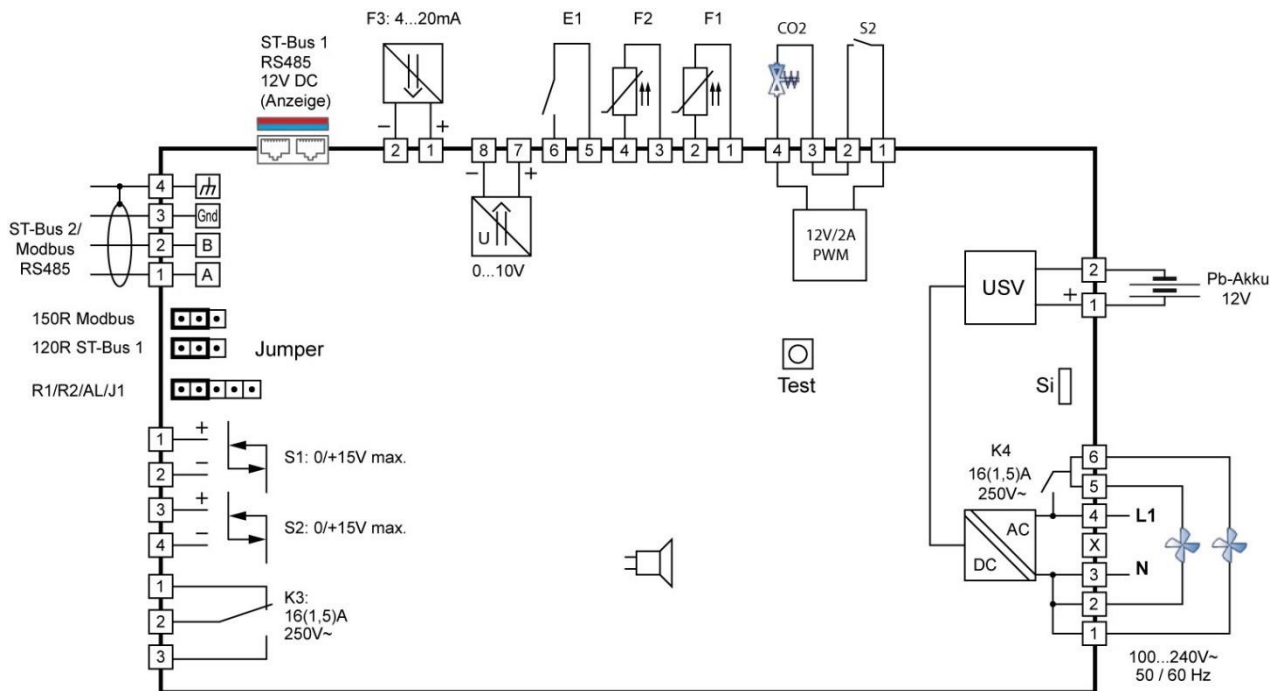

13 Spare parts list

13.1 Freezer cabinet VF 15040 / VF 15085

| Item No. | Order No. | Article |
|----------|-----------|--|
| 1 | 0011204 | Dryer, 1st stage |
| 2 | 0011162 | Compressor, 2nd stage (model VF15085 only) |
| 3 | 0011162 | Compressor, 1st stage (models VF15040 / VF15085) |
| 4 | 0012175 | Fan motor |
| 5 | 0011459 | Safety pressure switch |
| 6 | 0014321 | Casters |
| 7 | 0011415 | Manual stop valves |
| 8 | 0014587 | Door handle |
| 9 | 0017401 | Magnetic profile gasket |
| 10 | 0014423 | Door hinge, top |
| 11 | 0014422 | Door hinge, bottom |
| 12 | 0017433 | Silicone gasket |
| 13 | | Cover panel |
| 14 | 0011204 | Dryer, 2nd stage (model VF15085 only) |
| 15 | 0013111K | Temperature probe PT100 |
| | 96403088 | Top flap mounting |
| | 96403089 | Bottom flap mounting |
| | 0013792 | Single-board cryostat |
| | 0013794 | Touch screen unit |

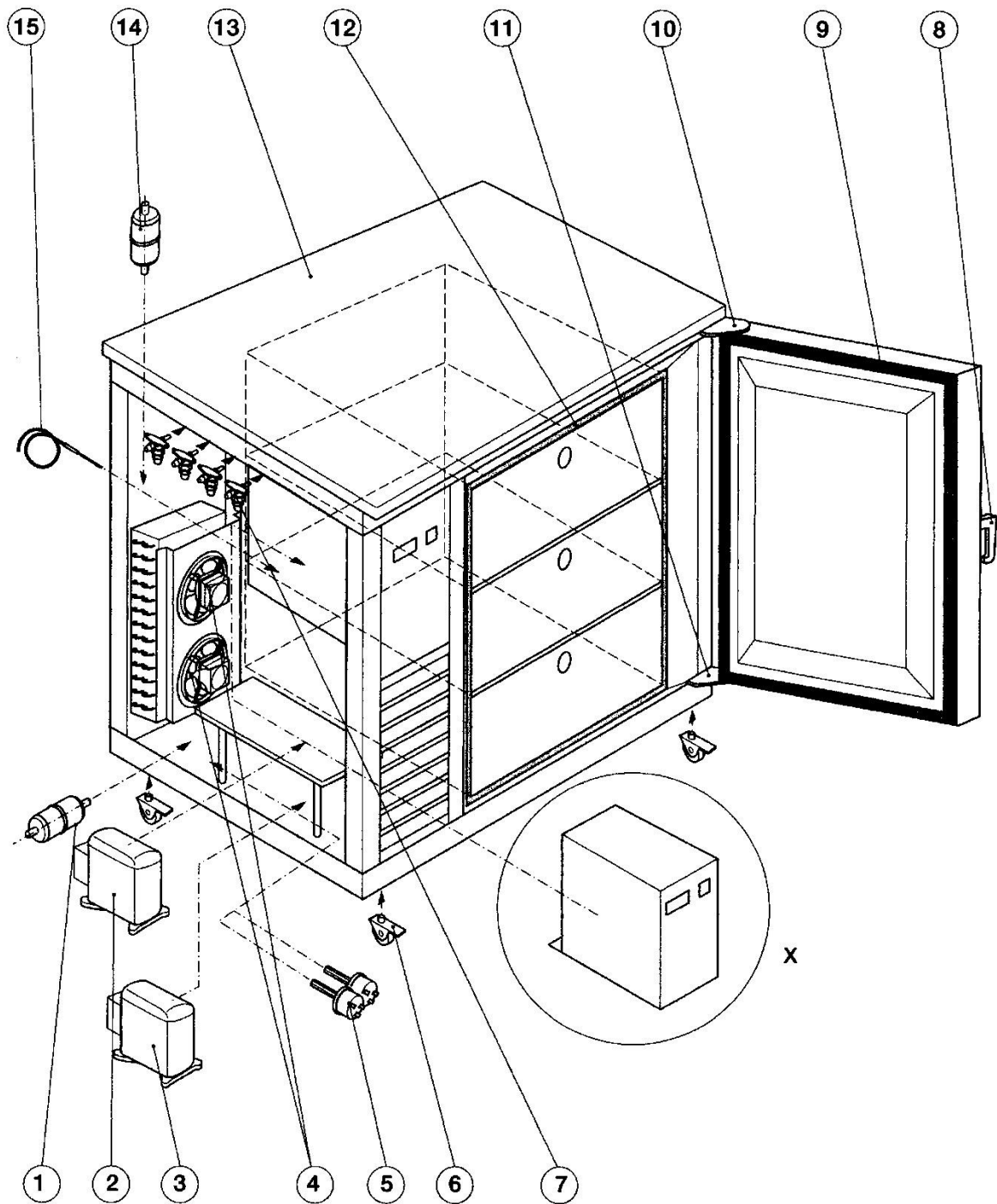

13.2 Freezer cabinet VF 60040, VF 60085 / VF 70040, VF 70085

| Item No. | Order No. | Article |
|----------|--------------|--|
| 1 | 0013111K | Temperature probe PT100 |
| 2 | 0011204 | Dryer |
| 3 | 0014327 | Caster without locking device |
| 4 | 0011415 | Manual stop valve |
| 5 | 0014326 | Caster with locking device |
| 6 | 0012191 | Fan motor |
| 7 | 0011459 | Pressure switch |
| 8 | 0011204 | Dryer |
| 9 | 0011160 | Compressor for 2nd stage for VF60085 / VF70085 |
| 10 | 0011159 | Compressor for 1st stage for VF60040, VF70040, VF60085 and VF70085 |
| 11 | 0014566 | Door handle, complete |
| | 0014569 | Pressure cylinder lock |
| 12 | 0017411 | Magnetic profile gasket |
| 13 | 0021272 | Inner flap |
| | 96403080 | Flap rail |
| | 96403088 | Top flap mounting |
| | 96403089 | Bottom flap mounting |
| 14 | 9VF600000019 | Handle rail 1 |
| | 9VF600000020 | Handle rail 2 |
| | 9VF600000021 | Handle rail 3 |
| | 9VF600000022 | Handle rail 4 |
| | 9VF600000023 | Handle rail 5 |
| | 9VF600000024 | Handle rail 6 |
| | 9VF600000025 | Handle rail 7 |
| 15 | 0017433 | Silicone gasket |
| | 0013792 | Single-board cryostat |
| | 0013794 | Touch screen unit |

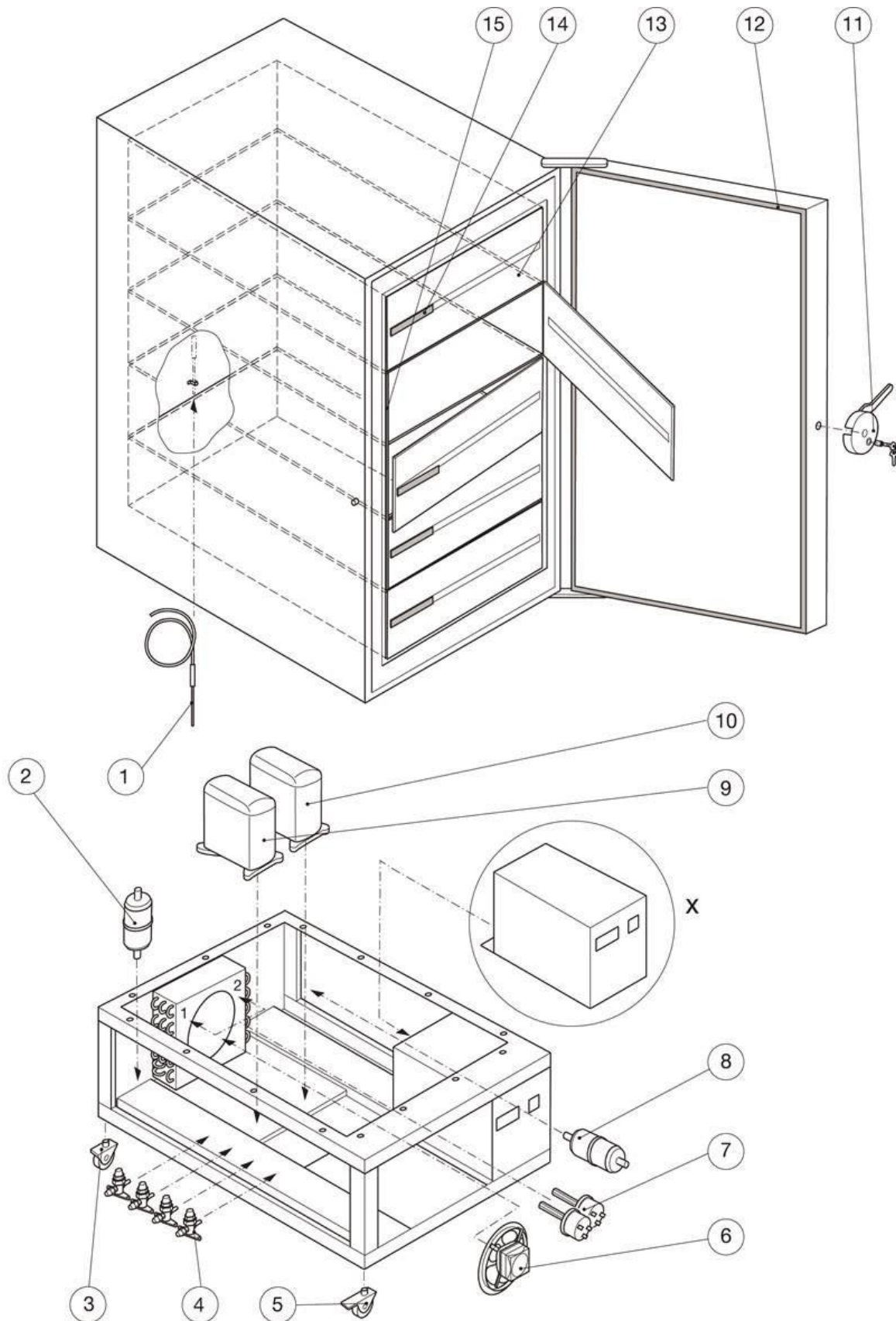

13.3 Electrical Switchgear

| Order No. | Article |
|-----------|---|
| 0012095 | Lead fleece battery 12 V / 12 Ah |
| 0011459 | Pressure switch |
| 0012528 | Electronic relay (SSR1 / SSR2) |
| 0012520 | Contactors |
| 0012435 | Protective cap |
| 0012426 | Main switch |
| 0012542 | Solenoid valve for models VF 60040 and VF 70040 |
| 0012096 | Adapter M22 RJ45 socket |
| 0012443 | Door switch |
| 0012852 | Patch cable 0.5 SW 0.5 m RJ45 for VF15040 and VF 15085 |
| 0012853 | Patch cable 1 SW 1.0 m RJ45 for VF15040 and VF 15085 |
| 0012854 | Patch cable 3 SW 3.0 m RJ45 for VF60040, VF70040, VF60085 and VF70085 |
| 0013111 K | Temperature sensor PT 100 |
| 0013792 | Single-board refrigeration controller |
| 0013794 | Touch control panel |
| 0011468 | Klixon for VF15040 and VF15085 |
| 0011469 | Starting capacitor / operating capacitor for VF15040 and VF15085 |
| 0011470 | Relay for VF15040 and VF15085 |
| 0011466 | Electrical box for VF60040, VF70040 and 1st stage VF60085, VF70085 |
| 0011467 | Electrical box for 2nd stage VF60085, VF70085 |
| 0012191 | Fan motor for VF60040, VF70040, VF60085 and VF70085 |
| 0012175 | Fan motor for VF15040 and VF15085 |

14 Auxiliary equipment

14.1 Data logger for monitoring and recording refrigeration compartment temperature

The data logger for the external monitoring and recording of refrigeration compartment temperatures is fitted with a PT1000 temperature probe with 3 m long PTFE insulated cable that is introduced into the refrigeration compartment via a feed-through integrated in the appliance or preferably a separate feed-through (optional).

The data logger has an adjustable limit value monitor with an acoustic alarm, and has sufficient memory for up to 60,000 measured values with recording intervals ranging from 1 second to 24 hours (adjustable).

The data can be exported directly to a PC via the supplied USB cable. Windows software (German, English and French) for configuring the data logger is included in the delivery.

Order no. A001383 Data logger

Incl. PT1000 temperature probe, bracket, software for configuring the data logger, and a USB cable for transferring data to a PC.

Accessories for data logger A001383

Order no. A001384 Temperature brake

Aluminium block for installing the temperature probe in the refrigeration compartment.
It delays the response time of the probe following changes in temperature.

Order no. A000147 Calibration

Calibration of data logger A001383 for a customer-specific temperature value; with certificate.

14.2 Storage system

14.2.1 Racks with drawers

| Model | Cabinet Litres | Contents | Order No for 1 Box | Number of racks per unit | Order No for 1 rack | Number of boxes/plates per rack | Number of boxes/plates per unit |
|----------------------|----------------|-------------------|--------------------|--------------------------|---------------------|---------------------------------|---------------------------------|
| VF 15040 VF 15085 | 129 l | Box 50 mm | A001386 | 9 | A001407 | 9 | 81 |
| | | Box 75 mm | A001387 | 9 | A001408 | 6 | 54 |
| | | Box 130 mm | A001388 | 9 | A001409 | 3 | 27 |
| | | Microtiter plates | | 6 | A001416 | 35 | 210 |
| VF 60040 VF 60085 | 584 l | Box 50 mm | A001386 | 35 | A001410 | 12 | 420 |
| | | Box 75 mm | A001387 | 35 | A001411 | 8 | 280 |
| | | Box 130 mm | A001388 | 35 | A001412 | 4 | 140 |
| | | Microtiter plates | | 35 | A001417 | 42 | 1470 |
| VF 70040 VF 70085 | 731 l | Box 50 mm | A001386 | 35 | A001413 | 15 | 525 |
| | | Box 75 mm | A001387 | 35 | A001414 | 10 | 350 |
| | | Box 130 mm | A001388 | 35 | A001415 | 5 | 175 |
| | | Microtiter plates | | 35 | A001418 | 56 | 1960 |

14.2.2 Racks with loading from the side

| Model | Cabinet Litres | Contents | Order No for 1 Box | Number of racks per unit | Order No for 1 rack | Number of boxes/plates per rack | Number of boxes/plates per unit |
|----------------------|----------------|----------------------------|--------------------|--------------------------|---------------------|---------------------------------|---------------------------------|
| VF 15040 VF 15085 | 129 l | not available for VF 150xx | | | | | |
| VF 60040 VF 60085 | 584 l | Box 50 mm | A001386 | 35 | A001401 | 12 | 420 |
| | | Box 75 mm | A001387 | 35 | A001402 | 8 | 280 |
| | | Box 130 mm | A001388 | 35 | A001403 | 4 | 140 |
| | | Deep Well-/Test plates | | 35 | A001419 | 18/54 | 630/1890 |
| VF 70040 VF 70085 | 731 l | Box 50 mm | A001386 | 35 | A001404 | 15 | 525 |
| | | Box 75 mm | A001387 | 35 | A001405 | 10 | 350 |
| | | Box 130 mm | A001388 | 35 | A001406 | 5 | 175 |
| | | Deep Well-/Test plates | | 35 | A001420 | 24/72 | 840/2520 |

14.2.3 Boxes

| | | Order-No: |
|---|------------------------|-----------|
| Cryo-Box, 136 x 136 x 50 mm, cardboard | white, water-repellent | A001386 |
| Cryo-Box, 136 x 136 x 75 mm, cardboard | white, water-repellent | A001387 |
| Cryo-Box, 136 x 136 x 130 mm, cardboard | white, water-repellent | A001388 |

14.2.4 Grid dividers

| | | Order-No: |
|--|------------------------|-----------|
| Grid divider for 100 tubes Ø 12,5 mm, height 25 mm | for boxes 136 x 136 mm | A001389 |
| Grid divider for 64 tubes Ø 15 mm, height 25 mm | for boxes 136 x 136 mm | A001390 |
| Grid divider for 49 tubes Ø 17 mm, height 40 mm | for boxes 136 x 136 mm | A001391 |
| Grid divider for 16 tubes Ø 31 mm, height 65 mm | for boxes 136 x 136 mm | A001392 |

EC DECLARATION OF CONFORMITY

Hereby we,

LAUDA-GFL Gesellschaft für Labortechnik mbH
Schulze-Delitzsch-Str. 4+5
30938 Burgwedel
Federal Republic of Germany

declare that the below stated **Versafreeze Deep Freezers** models:

VF 15040, VF 60040, VF 70040
VF 15085, VF 60085, VF 70085
VF 20040 C, VF 55040 C, VF 75040 C
VF 20085 C, VF 55085 C, VF 75085 C

with the technical data:

| 230 V, 50 Hz | 115 V, 60 Hz | Typ |
|--------------|--------------|---|
| 0.5 kW | 0.6 kW | VF15040 |
| 1.0 kW | 1.2 kW | VF15085 |
| 1.2 kW | 1.3 kW | VF60040, VF 70040, VF 55040 C, VF 75040 C |
| 2.0 kW | 2.2 kW | VF60085, VF 70085, VF 55085 C, VF 75085 C |
| 0.6 kW | 0.7 kW | VF 20040 C |
| 1.2 kW | 1.3 kW | VF 20085 C |

are in conformity with the following EC Directives:

| | | |
|-----|------------|-----------------------|
| I | 2006/42/EC | (Machinery Directive) |
| II | 2014/30/EU | (EMC Directive) |
| III | 2011/65/EU | (RoHS 2 Directive) |

For conformity **with I** the following standard was applied:

EN 61010-1:2010
EN 61010-2-011;2017

For conformity **with II** the following standard was applied:

EN 61326-1:2013

Authorized representative for the compilation of the technical documentation:

Mr Andreas Voigt at LAUDA-GFL

Nameplate

LAUDA-GFL Ges. für Labortechnik mbH

Andreas Degmayr
Managing director

Burgwedel, 01 July 2021

LAUDA-GFL Gesellschaft für Labortechnik mbH
Schulze-Delitzsch-Str. 4/5 - 30938 Burgwedel - DE

WEEE-Reg.-Nr.: DE 67770231
Amtsgericht Hannover - HRB 120071
VAT-ID.-No. DE15042911

Sparkasse Hannover
IBAN DE88 2505 0180 1050 2062 65
BIC SPKH DE 33 XXX

T +49 (0) 5139 9958-0 • F +49 (0) 5139 9958-21
info@lauda-gfl.de • www.lauda-gfl.de

Geschäftsführer:
Andreas Degmayr

LAUDA-GFL Gesellschaft für Labortechnik mbH
Schulze-Delitzsch-Straße 4+5 • 30938 Burgwedel • Germany
Phone: +49 (0) 5139 9958-0 • Fax +49 (0) 5139 9958-21
E-Mail: info@lauda-gfl.de • Internet: www.lauda.de/de/lauda-gfl