

BAKER

RUSKINN

User Manual UM-038

InvivO₂ 1000

Dual Chamber Hypoxia Workstation

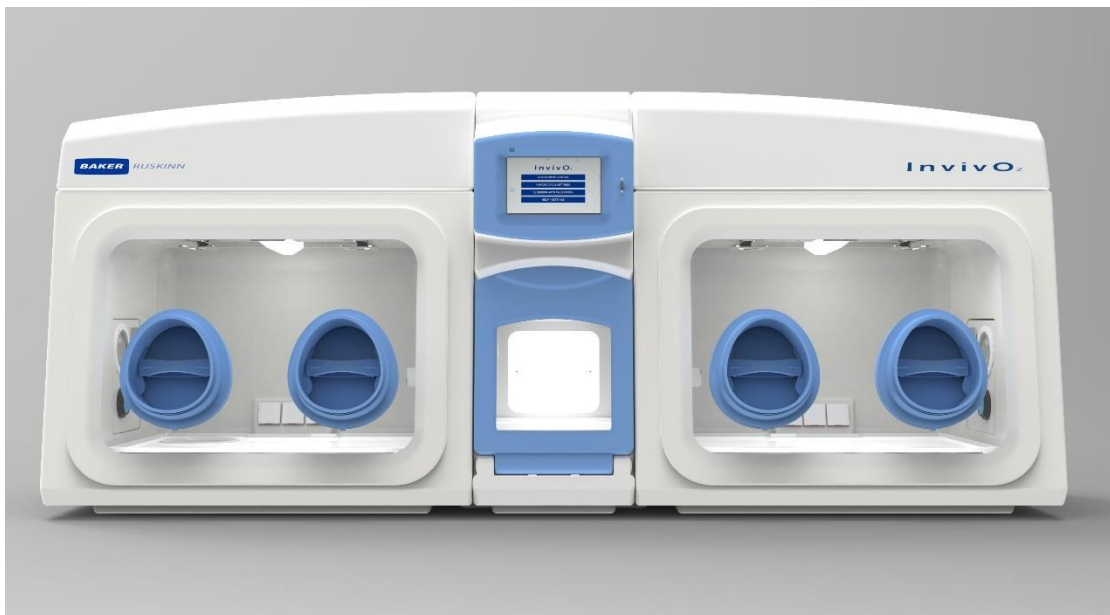

InvivO₂ 1000

Affix Serial Number Sticker Here

CONTENTS

TABLE OF FIGURES	III
TABLE OF SCREEN IMAGES.....	IV
TABLE OF SCREEN ICONS	IV
TABLE OF TABLES	V
INTRODUCTION	1
SAFETY INSTRUCTIONS	2
REGULATORY COMPLIANCE	3
EUROPEAN REGION	3
NORTH AMERICAN REGION	4
PRECAUTIONS	4
SYMBOLS	5
TRANSPORT AND STORAGE	6
LOCATION AND HANDLING OF THE INVIVO2 WORKSTATION	6
ENVIRONMENTAL OPERATING CONDITIONS	6
SERVICE REQUIREMENTS	7
ELECTRICAL SUPPLY REQUIREMENTS.....	7
GAS SUPPLY REQUIREMENTS	8
INVIVO2 1000 DUAL WORKSTATION OVERVIEW	9
FRONT VIEW	9
FRONT INTERIOR VIEWS	10
LEFT SIDE VIEW	11
REAR VIEW	12
USING THE WORKSTATION.....	13
USING THE INTERLOCK	13
INTERLOCK OVERVIEW	13
OPERATING THE INTERLOCK OUTER DOOR.....	13
OPERATING THE INTERLOCK INNER DOORS	14
TRANSFERRING MATERIAL INTO THE WORKSTATION CHAMBER VIA THE INTERLOCK	14
REMOVING MATERIAL FROM THE WORKSTATION CHAMBER VIA THE INTERLOCK.....	16
HAND ACCESS TO THE MAIN CHAMBER	17
VACUUM OPERATION.....	18
WORKSTATION ENTRY	20

WORKSTATION EXIT 22

HUMIDITY CONTROL 23

SCREENS 30

 MAIN SCREEN 30

 LEFT AND RIGHT WORKSTATION MAIN MENUS 31

 INVIVO₂ INITIAL SETTINGS SCREEN 32

 ENVIRONMENT CONTROL 34

 WORKSTATION OVERVIEW 35

 WORKSTATION SWITCHING 36

 WORKSTATION ENVIRONMENT CONTROL SCREENS OVERVIEW 36

 DATA LOGS 37

 UTILITIES 38

 HYPOXIC CYCLE 39

 OXYGEN SENSOR CALIBRATION 42

 HELP / SETTINGS 43

 WARNINGS 44

USB TREND LOG 49

CLEANING AND SERVICE REQUIREMENTS 50

 SERVICE AND CLEANING OVERVIEW 50

 CLEANING PROCEDURE – DURING AND AFTER EACH USE 51

 CLEANING PROCEDURE – DEEP CLEAN WITH FRONT SCREENS REMOVED 52

 1 YEAR SERVICE 55

TROUBLESHOOTING 57

 THE WORKSTATION WILL NOT SWITCH ON 57

 THE CIRCUIT BREAKER TRIPS 57

 LOW GAS PRESSURE 57

 EXCESSIVE GAS USAGE 58

 INTERNAL EQUIPMENT NOT POWERING UP 58

 THE WORKSTATION IS ONLY PARTIALLY OPERATIONAL 58

WARRANTY INFORMATION 59

DISPOSAL INFORMATION 60

CONTACT DETAILS 61

TABLE OF FIGURES

Figure 1: Rear Connections	7
Figure 2: Gas Connection Graphic	8
Figure 3: InvivO ₂ Dual Workstation.....	9
Figure 4: InvivO ₂ Internal View from Left.....	10
Figure 5: InvivO ₂ Internal View from Right.....	10
Figure 6: Left Side End Panel with Ultrasonic Humidity Option	11
Figure 7: Rear End Panel and Supply Connections	12
Figure 8: Gas and Electrical Connections	12
Figure 9: Ezee -Sleeves.....	17
Figure 10: Compressed Ezee-Sleeve for Entry.....	18
Figure 11: Arm inserted into Ezee-Sleeve (Shown with and without Ezee-Sleeve).....	18
Figure 12: Foot pedals for right and left glove ports	19
Figure 13: Ezee-Sleeve before vacuum.....	19
Figure 14: Ezee-Sleeve after vacuum	19
Figure 15: Glove port cap	20
Figure 16: Glove port cap stowage and locator	20
Figure 17: Glove port cap storage location inside workstation.....	21
Figure 18: Glove port cap	22
Figure 19: Glove Port Locator	22
Figure 20: Aquasorb Sachets - Empty and Charged.....	23
Figure 21: Aquasorb Sachet in Workstation.....	23
Figure 22: Humidity System Water Tank.....	24
Figure 23: Water Tank Thumb Screw	25
Figure 24: Water Tank lowered for removal	25
Figure 25: Water Tank tilted forward partially removed	26
Figure 26: Water Tank top tube removal	26
Figure 27: Water Tank electrical connector	27
Figure 28: Water Tank bottom lifted out	27
Figure 29: Water Tank bottom tube disconnection	28
Figure 30: Condensate Plate	29
Figure 31: Condensate Output and Tray	29
Figure 32: Workstation Environment Control Screens Overview	36
Figure 33: Front Screen Pneumatic Connector Disconnection	52
Figure 34: Ceiling Panel Thumb Screws.....	55
Figure 35: Ceiling Panel Handle and Grab Catch.....	55
Figure 36: Large Detox Sachet.....	56
Figure 37: Gloveport Sleeves.....	56

TABLE OF SCREEN IMAGES

Screen 1: Interlock Purge	15
Screen 2: Interlock Purge Timer	15
Screen 3: Workstation Selection	30
Screen 4: Left Main Menu	31
Screen 5: Right Main Menu	31
Screen 6: InvivO ₂ Initial Settings Screen with Ultrasonic Humidity Option	32
Screen 7: Oxygen Level Set-point Pop-up	32
Screen 8: Initial Settings Screen with Aquasorb Humidity.....	33
Screen 9: Environment Control Overview.....	34
Screen 10: Exit Gas Control Warning	34
Screen 11: Workstation Overview	35
Screen 12: Workstation Not in Use	35
Screen 13: Trend Log.....	37
Screen 14: Utilities Menu	38
Screen 15: Hypoxic Cycle Menu - Continuous Cycle On	39
Screen 16: Hypoxic Cycle Menu - Continuous Cycle Off.....	40
Screen 17: Hypoxic Cycle Temperature and Humidity Settings	41
Screen 18: Oxygen Sensor Calibration.....	42
Screen 19: Help / Settings Menu	43
Screen 20: Temperature Alarm Screen.....	44
Screen 21: Water Tank Low Warning Screen.....	45
Screen 22: USB Memory Warning Screen	46
Screen 23: Gas Mix Time Limit Warning Screen	47
Screen 24: Input Gas Pressure Alarm	48

TABLE OF SCREEN ICONS

Icon 1: Interlock Outer Door	13
Icon 2: Humidity Low Alarm.....	24
Icon 3: Workstation Overview	35
Icon 4: Internal Lights Control	38
Icon 5: Front Screen Release.....	52

TABLE OF TABLES

Table 1: List of Symbols	5
Table 2: Electrical Service Requirements	7
Table 3: Fuse Ratings	7
Table 4: Standard Gases	8
Table 5: Additional gases for specific operating modes.....	8
Table 6: Settings screen column functions.....	32
Table 7: Audible Alarm Sounds.....	48
Table 8: Trend Log Data Fields	49
Table 9: Cleaning and Service Details.....	50

INTRODUCTION

Please read this manual carefully before using the InvivO₂ and familiarise yourself with all aspects of using the workstation. The Baker Company (Baker) or Ruskinn Technology Ltd (Ruskinn) does not accept responsibility for accidents to personnel or damage to the InvivO₂ workstation resulting from incorrect use.

The InvivO₂ has been specifically designed and developed to meet the requirements of all laboratories. The unit is ergonomically laid out to ensure maximum operator comfort and optimization of space for media preparation, manipulation, and analysis. InvivO₂ is designed to give optimum 'in-vitro' conditions for cell culture in a simple and easily controlled manner.

The system has built in gas control with Oxygen and Carbon Dioxide sensors to enable constant monitoring of the atmosphere. Hypoxic conditions are created using Nitrogen (N₂), Carbon Dioxide (CO₂) and Compressed Air (O₂) (or 25% Oxygen in Nitrogen) to achieve the desired atmosphere. The user can select the Oxygen concentration from 0.1% to 20.9%, and Carbon Dioxide concentrations from 0.1% to 30.0%.

A Heater system maintains the temperature within the workstation between ambient +5°C to 45°C, which is set by the user. The cooling accessory for the workstation will achieve an unloaded temperature down to 15°C which is set by the user.

Optional humidity generation system allows the maintenance of Relative Humidity levels from ambient to +85% RH @ 37°C which is user defined. The generation of humidity is either through Aquasorb sachets or Nebulisation which promotes evaporation from a body of water by breaking the surface tension.

Many unique features of the InvivO₂ workstation are covered in detail in this manual. It is recommended that the user be fully conversant with the instruction and procedures, and that the operator familiarises themselves with all aspects and functions of the system before it is commissions to maintain optimum performance.

SAFETY INSTRUCTIONS

Baker and/or Ruskinn do not take any responsibility for damages caused by using the equipment for other purposes than described in this user manual.

- The mains appliance coupler and plug are the AC mains supply isolation device and must be easily accessible when installed.
- In case of emergency disconnect the InvivO₂ from the AC Mains Outlet.
- Ensure that the connecting cable is not squeezed or bent when the unit is being installed or moved.
- All installation work and adjustments to the unit must be carried out by qualified personnel. Work performed by persons with insufficient technical knowledge may adversely affect the performance of the unit or cause physical injury or damage to the equipment.
- All servicing and repairs must be carried out by a qualified customer service engineer. Only genuine spare parts must be used.
- In case of damage to the InvivO₂ disconnect the workstation from the mains outlet and contact your local distributor.
- All covers and lids must only to be removed by a qualified service engineer.
- Nothing should be placed on the top of the workstation.
- A power cord supplied with the workstation and should be used to connect to the mains outlet. If a replacement is required it must be adequately rated for the application.
- All cables and pipes should be routed to ensure that they do not pose a trip hazard.
- Mains supply Voltage fluctuation must not exceed $\pm 10\%$ of the nominal Voltage.
- Gas regulators must be used for each gas supply. A 2 stage regulator is recommended with a maximum supply pressure of 4 Bar. Over pressure could damage the workstation.
- Only the gases specified in this user manual may be used.
- All gas bottles must be adequately secured before connection to the workstation.
- The maximum power rating of the internal sockets must not be exceeded.
- The end user is responsible for all materials and equipment places inside the workstation.
- Before connecting any equipment to the internal mains sockets ensure that the equipment has or is connected to a protective earth. If in doubt please contact the equipment manufacturer.
- The workstation must not be operated at an ambient temperature over 30°C.
- The cooling fan covers and cooling vents must not be covered or blocked.
- The weight limit for the workstation internal floor is 30kg and must be evenly distributed.
- The weight limit for the interlock tray is 5kg and must be evenly distributed.
- There should be no naked flames close to the workstation.
- The use of radioactive materials is strictly prohibited.

CAUTION: Asphyxiation Risk

The InvivO₂ uses Nitrogen (N₂) and Carbon Dioxide (CO₂) as part of normal use with the volume released externally is inconsequential. In the event of a leak or malfunction this gas release may become excessive. DO NOT OPERATE this unit in a SMALL ENCLOSURE such as a small room or walk-in closet. An accidental release of Nitrogen or Carbon Dioxide could create an asphyxiating atmosphere in a small space.

If the equipment is not used in a manner specified by the manufacturer, the protection provided by the equipment may be impaired.

Failure to adhere to these safety instructions could cause serious injury and will invalidate the workstation warranty. Ruskinn technology limited accepts no responsibility for any accident, injury or loss caused by unsafe operation of the workstation.

REGULATORY COMPLIANCE

European Region



This product complies with the essential EEA requirements for Electrical Safety and Electromagnetic compatibility as set out in the EMC Directive 2014/30/EU, the Low Voltage Directive 2014/35/EU and hazardous substances (RoHS) Directive 2011/65/EU has been tested and found to comply in full.

For details on standards tested refer to the DoC Certificate.

WEEE:



This equipment must be disposed of in accordance with the Waste from Electrical and Electronic Equipment (WEEE) Directive

This product must not be treated as household waste. Instead, it shall be handed over to an appropriate collection point for the recycling of electrical and electronic equipment.

If in doubt, please return this equipment to Ruskinn Technology Ltd who will correctly dispose of it for you. We strongly recommend that this product is returned to RTL at the end of its useful life.

North American Region



This product is UL 61010-1 Listed, and CSA C22.2 No. 61010-1 under file number E113911.

This equipment has been tested and found to comply with the limits for a Class A digital device, pursuant to part 15 of the FCC Rules. These limits are designed to provide reasonable protection against harmful interference when the equipment is operated in a commercial environment. This equipment generates, uses, and can radiate radio frequency energy and, if not installed and used in accordance with the instruction manual, may cause harmful interference to radio communications. Operation of this equipment in a residential area is likely to cause harmful interference in which case the user will be required to correct the interference at his own expense.

Precautions

The InvivO₂ has been tested and approved to EN61010-1, 61326-1, and 61326-2-6. This means that the InvivO₂ meets or exceeds the requirements for General and IVD electrical Laboratory equipment in terms of its levels of emitted electromagnetic (EM) radiation and its susceptibility to electromagnetic radiation from other devices. It should be noted that the InvivO₂ may be affected by high levels of stray EM radiation from other electronic devices (even those which comply with relevant CISPR emission standards) that are being used in close proximity to it.

WARNING: This system may cause radio interference or may disrupt the operation of nearby equipment. It may be necessary to take mitigation measures, such as re-orienting or relocating the equipment or shielding the location.

Symbols

Before using the InvivO₂, please ensure that you are familiar with the symbols.









Symbol	Meaning
	Refer to user manual.
~	Alternating current
0	Off
I	On
	Functional Earth Connection
	Protective Earth Connection
CE	This product complies with the essential EEA requirements for Electrical Safety and Electromagnetic compatibility as set out in the EMC directive 2004/108/EC and the Low Voltage Directive 2006/95/EC
	Caution, do not remove covers. No end user serviceable parts behind covers. Please refer to this manual in all cases where this symbol appears, in order to find out the nature of the Potential Hazard and actions to be taken in order to avoid the Hazard.
	Warning, this equipment contains high voltage circuitry.
	Contains material or substances that may be hazardous to human health. Please refer to your local biohazardous material handling procedure for further advice on the handling and disposal of these items.
	InvivO ₂ contains hazardous components and must not be disposed of at a household waste site. Instead it should be taken to the appropriate collection point for the recycling of electrical and electronic equipment.
	USB socket
	Date of manufacture in format YYYY MM

Table 1: List of Symbols

TRANSPORT AND STORAGE

When not in use, the InvivO₂ Workstation must only be stored within a temperature of between 0°C and 30°C

Storage outside of this range may damage the workstation.

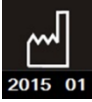
LOCATION AND HANDLING OF THE INVIVO2 WORKSTATION

The InvivO₂ Workstation should only be installed or relocated by a qualified engineer. To arrange installation or relocation please contact your local distributor.

The mains appliance coupler and plug are the AC mains supply isolation device and must be easily accessible.

ENVIRONMENTAL OPERATING CONDITIONS

The InvivO₂ Workstation should only be operated under the following environmental conditions:

- Temperature – Between 15°C and 30°C
- Humidity – Between ambient and 90% RH, Non-Condensing

The workstation must be located in a well-ventilated area.

SERVICE REQUIREMENTS

Electrical Supply Requirements

The workstation must be connected to a mains power supply. Two power cords are supplied to connect the workstation to the mains supply. If alternative power cords are used they must be rated appropriately for the power requirements of the workstation, refer to Table 2. The workstation must be connected to a protective earth.

To ensure safe operation of the workstation, it must be connected to a supply of the correct voltage and frequency as stated on the rating label shown at the rear of the unit. The mains supply voltage fluctuations must not exceed +/- 10% of the nominal mains voltage. The input voltage and frequency for each of the InvivO₂ 1000 Dual workstations are:

Voltage Range	Frequency	Nominal Power	Rated Current	Rated Power
220 to 240 Vac	50/60Hz	360W	8.1A	1830W
110 to 120 Vac	50/60Hz	360W	14.3A	1600W
100 Vac	50/60Hz	360W	15.7A	1570W

Table 2: Electrical Service Requirements

Please note that the applicable ratings for the Workstation configuration are detailed the labelling at the rear of the product as shown in Figure 1.

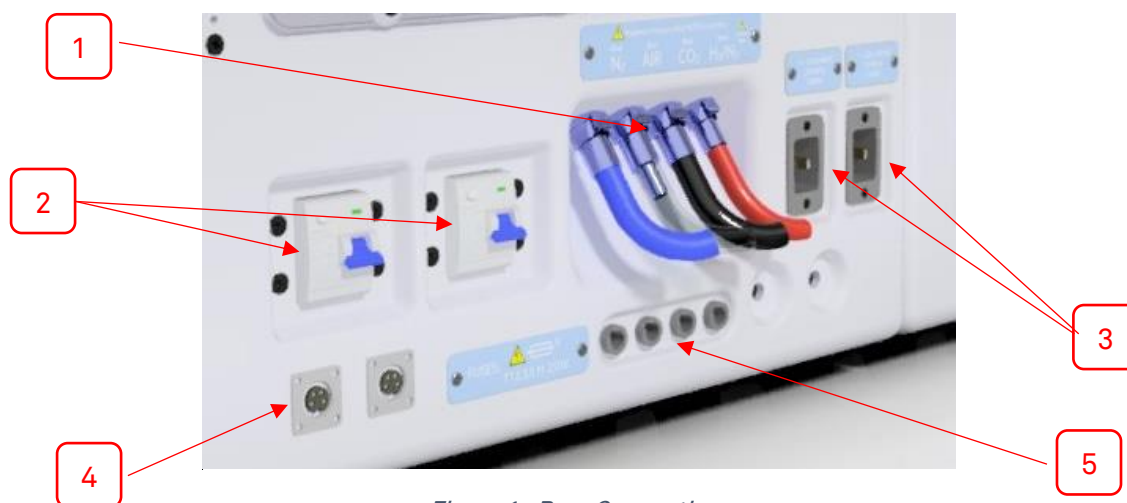

Figure 1: Rear Connections

1. Gas Supplies
2. Residual Current Circuit Breakers (RCCB)
3. Mains Input Connectors (C19)
4. Footswitch Connectors
5. Mains Input Fuses

The Workstation is double pole fused (Live and Neutral) for protection against over current draw. The fuses fitted are based on the voltage range applicable, see Table 3 for details:

Voltage Range	Mains Input Fusing
220-240 Vac	T10A H250V
100 Vac, 110-120 Vac	T16A H250V

Table 3: Fuse Ratings

Gas Supply Requirements

The workstation gas supplies are located at the rear of the unit as shown in Figure 1.

For standard physiological environment operation of the workstation the gas requirements are:

Gas	Symbol	Specification	Regulator Output Pressure
Nitrogen	N ₂	Oxygen Free (Industrial or medical)	58 to 72.5psi (4 to 5 bar)
Carbon Dioxide	CO ₂	100% (Industrial or medical)	42 to 49psi (3 to 3.5 bar)
Air	N/A	Compressed (Industrial or medical)	42 to 49psi (3 to 3.5 bar)

Table 4: Standard Gases

Additional operational modes are available which will require the following gas connections:

Gas	Symbol	Specification	Replaces	Use	Regulator Output Pressure
5% Hydrogen in Nitrogen*	H ₂ /N ₂	Maximum of 5.5% Hydrogen in Nitrogen (Industrial or medical)	N/A	For anoxic mode	42 to 49psi (3 to 3.5 bar)
25% Oxygen in Nitrogen	O ₂ /N ₂	Maximum of 25% Oxygen in Nitrogen (Industrial or medical)	Air	For oxygen levels between 17% and 23%	42 to 49psi (3 to 3.5 bar)

Table 5: Additional gases for specific operating modes



Figure 2: Gas Connection Graphic

For the gas supply we recommend direct connections of the gas bottle regulator to ensure minimal pressure drops and flow rate restrictions.

The gas regulator should provide a minimum supply pressure of 3 bar gauge. The maximum supply pressure permissible is 5 bar gauge. A supply pressure greater than this will damage internal components of the InvivO₂ 1000 Dual Workstation and will invalidate the warranty.

Only the above stated gases are to be used with the workstation. Failure to comply with this may cause the product to become hazardous.

* - Recommended Hydrogen concentrations are compliant to BS EN ISO 10165:2010 (Classification of Flammable Gasses). The use of Hydrogen concentrations up to a

maximum of 10% in Nitrogen (N₂) is the responsibility of the user and must be assessed by the user in accordance to local safety regulations at the installation location.

INVIVO2 1000 DUAL WORKSTATION OVERVIEW

Front View

The Invivo₂ Dual Workstation is shown below in Figure 3.

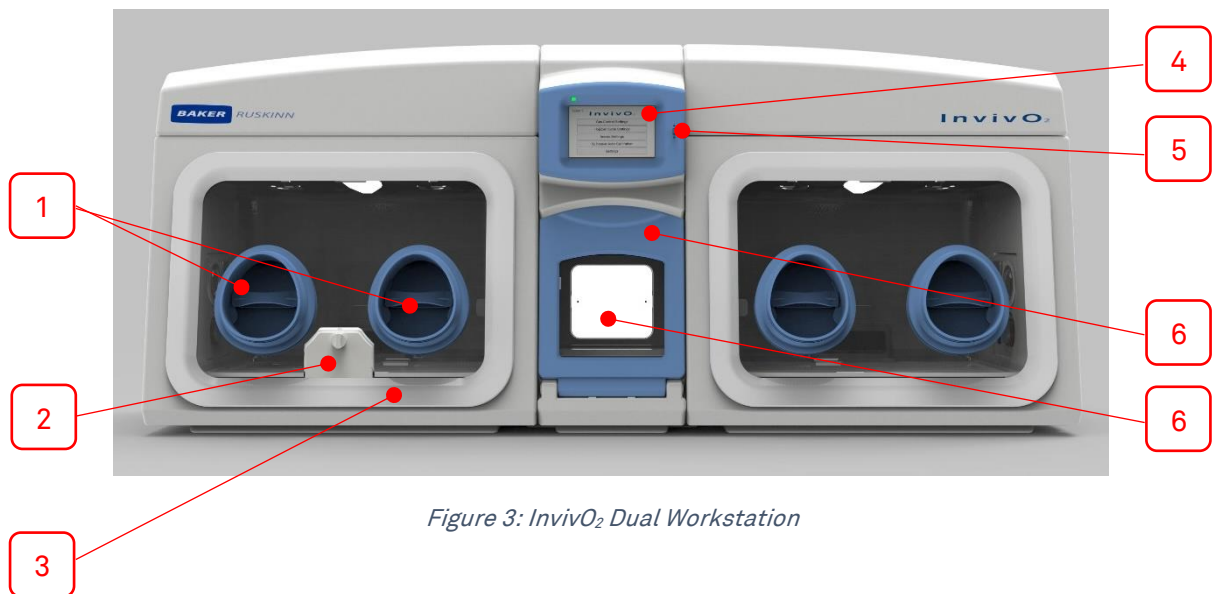

Figure 3: Invivo₂ Dual Workstation

1. Ezeeyin Glove Ports
2. Single Plate Entry System (SPES) (Optional Accessory)
3. Removable Front Screen
4. Touch Screen
5. USB Port
6. Interlock Outer Door
7. Interlock Light Panel

Front Interior Views

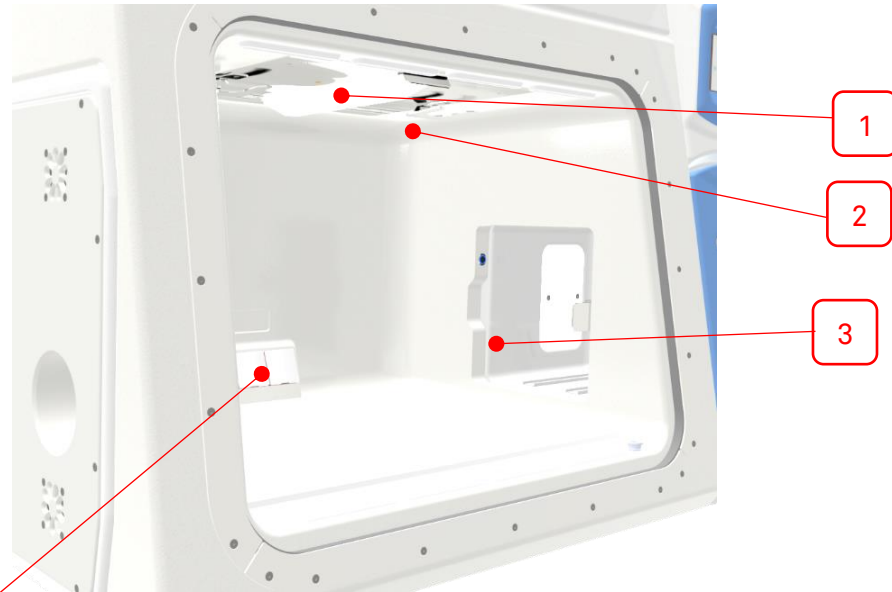

Figure 4: InvivO₂ Internal View from Left

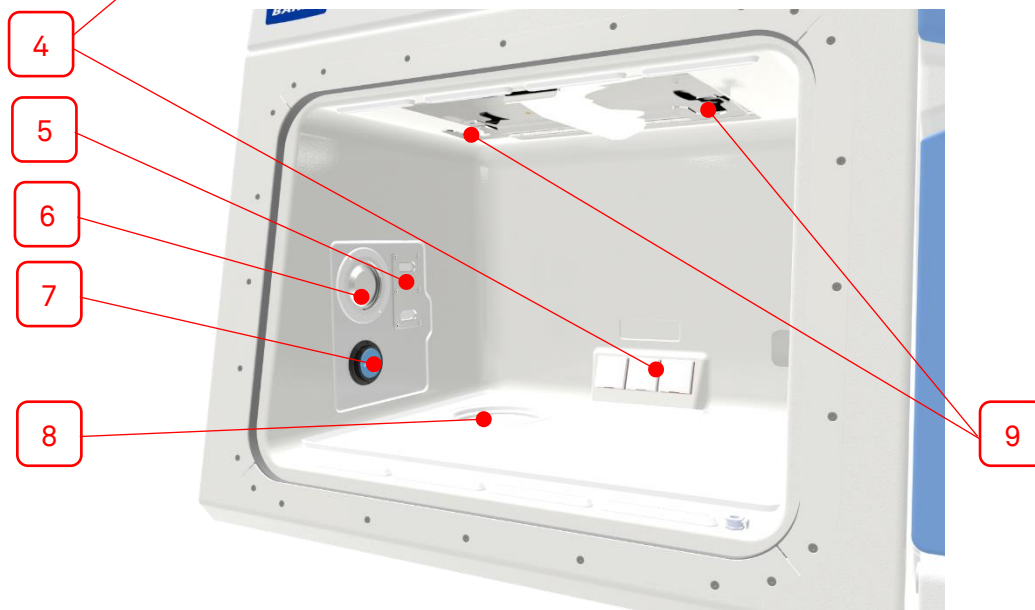

Figure 5: InvivO₂ Internal View from Right

1. Internal Light
2. Temperature and Humidity Sensor Housing
3. Internal interlock door
4. Internal sockets
5. Humidity Outlet (Optional)
6. Condensate plate
7. Universal Port (Optional)
8. Waste Port (Optional)
9. Glove Port Cap Stowage

Note: For the right side of the Dual Workstation the location of all parts is a mirror image of the left

Left Side View

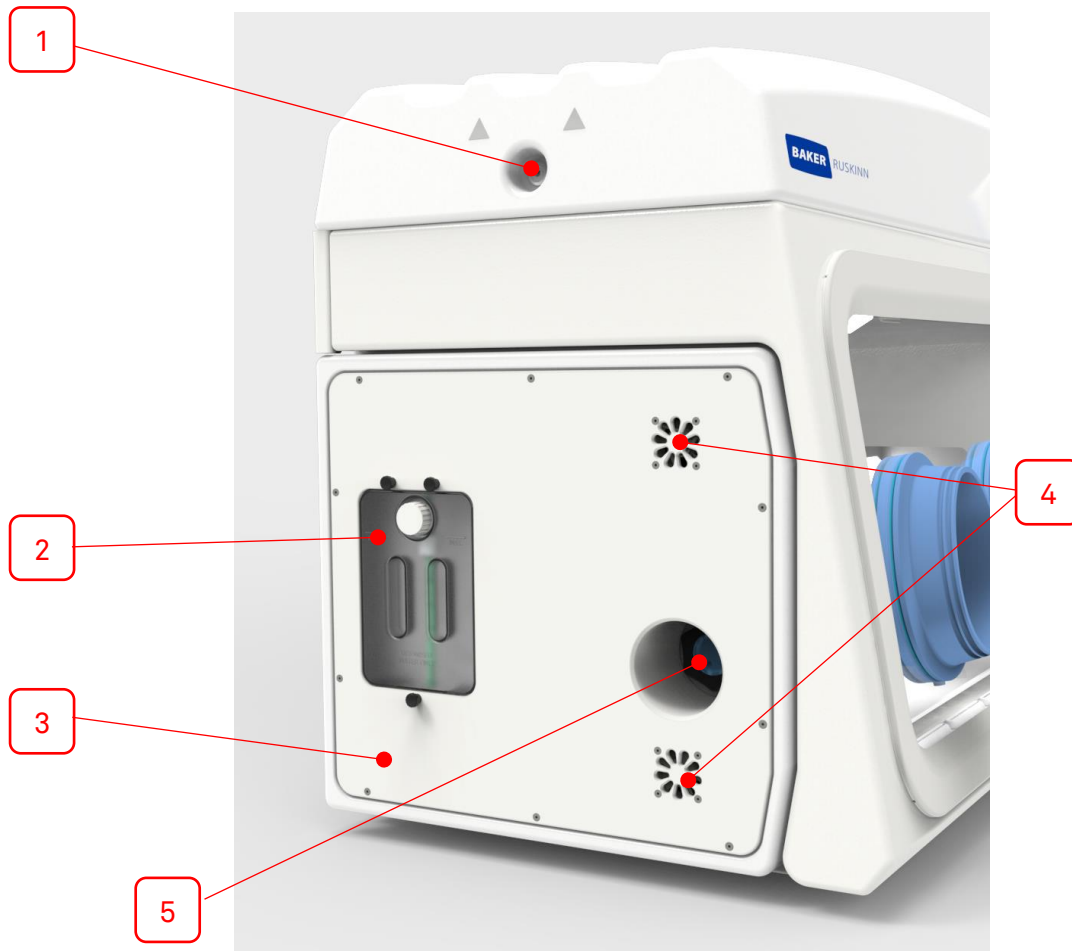

Figure 6: Left Side End Panel with Ultrasonic Humidity Option

1. Lid – Service access only
2. Humidity water tank (Optional)
3. Side Panel – Service access only
4. Cooling vent – Do not obstruct
5. Universal Port (Optional)

Note: for the right side the location of all parts is a mirror image of the left side

Rear View

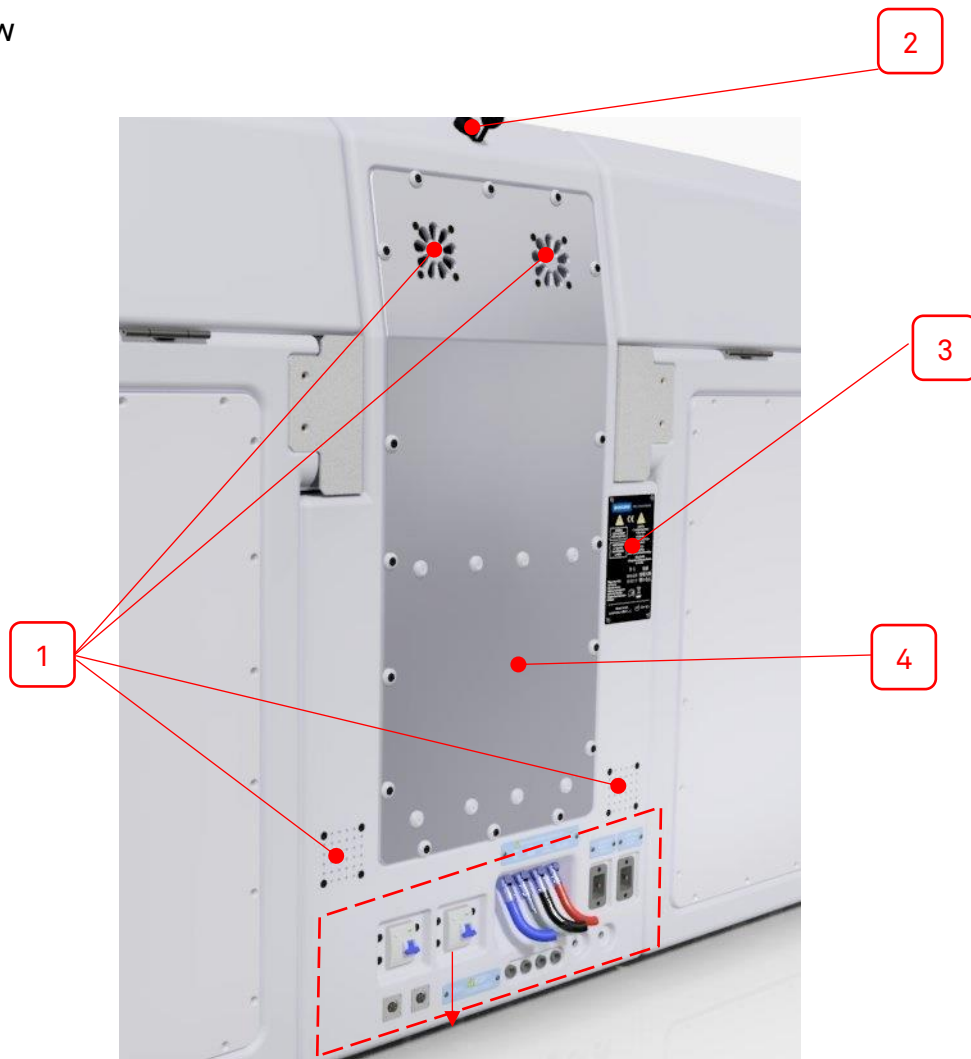

Figure 7: Rear End Panel and Supply Connections



Figure 8: Gas and Electrical Connections

1. Ventilation Holes
2. Ethernet Port (For use with Remote Monitoring Option Only)
3. Safety label
4. Rear panel – Service access only

See **Service Requirements** section for further details on electrical and gas connections.

USING THE WORKSTATION

Using the interlock

The InvivO₂ 1000 Dual workstation has a 49 litre interlock and is used for transferring materials and samples into and out of the workstation chamber and pre-conditioning the atmosphere to not affect the internal workstation atmosphere.

As an optional extra (External HEPA containment package) the purge facility can be operated for both entering and exiting the workstation. When transferring samples out of the workstation the interlock purge cycle must be run before the interlock outer door can be opened.

Interlock Overview

The interlock consists of 4 main components;

- Interlock outer door.
- Interlock inner door.
- Interlock chamber.
- Interlock floor tray.

The interlock is accessed by opening either the outer or inner door.

Operating the interlock outer door

Before opening the interlock outer door, check that the interlock inner door is closed. To open the interlock outer door, go to the Utilities menu from the gas control screen, push and hold the icon of the interlock outer door.



Icon 1: Interlock Outer Door

The door lock will release and the door will move towards you slightly. The door can then be pulled down to open fully. To close the interlock outer door, push the door closed and the magnetic lock will re-engage. Do not place object(s) on the interlock outer door when open, as this may damage the workstation.

Operating the interlock inner doors

The interlock inner doors can only be opened if the interlock has been purged, indicated on the touchscreen, and the inner door push buttons being illuminated. To open the interlock inner door:

- Access the workstation chamber via the Ezeeyin glove ports after putting your arm through the Ezee-Sleeves.
- Press the interlock inner door button.
- Slide the interlock inner door backwards to open.

To close the interlock inner door, slide the door forwards.

Note: The interlock inner door should only be open when transferring materials from the interlock chamber to the workstation chamber and vice versa. The interlock inner door can be opened and closed as often as required to transfer material, providing the outer door has not been opened. Only 1 of the inner interlock doors can be opened at a time; for transferring media or materials between the two workstation chambers the items should be loaded onto the interlock floor tray, the inner door closed and then the other inner door can be opened.

Transferring material into the workstation chamber via the interlock

To transfer material into the workstation chamber via the interlock;

- Open the interlock outer door (push button for >3 seconds)
- Pull the interlock outer door down until it is horizontal.
- Place the required items on the interlock tray. The weight limit for the tray is 10kg.
- Close the interlock outer door.
- Start the interlock purge by either selecting one of the two icons on the touch screen or by pressing the inner interlock door button. The button will activate a 0% purge.
 - The fast purge icon purges the interlock down to the lowest Oxygen level of the two main chambers. This will allow the internal working environments to be unaffected by the introduction of new cells / samples.

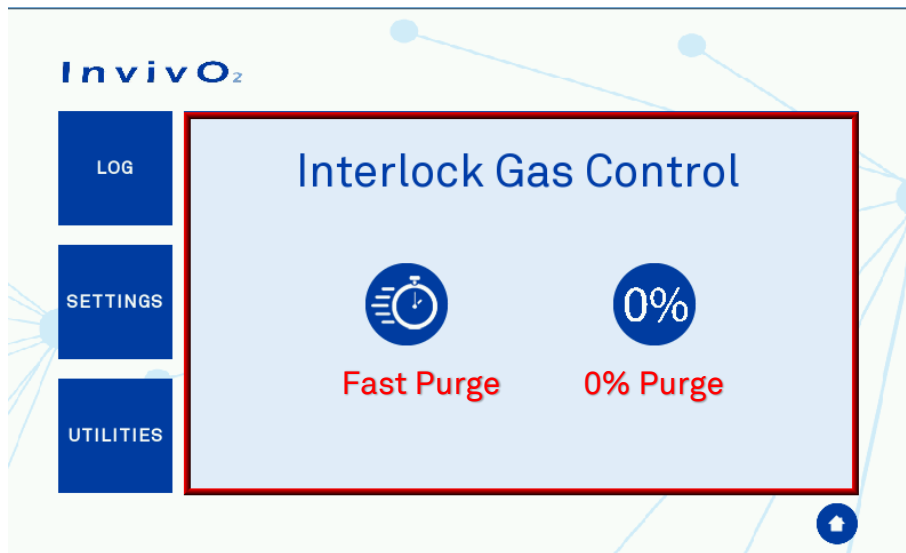

Screen 1: Interlock Purge

- The interlock cycle status purge timer will appear on the touchscreen and count down the time remaining to achieve the required Oxygen level.

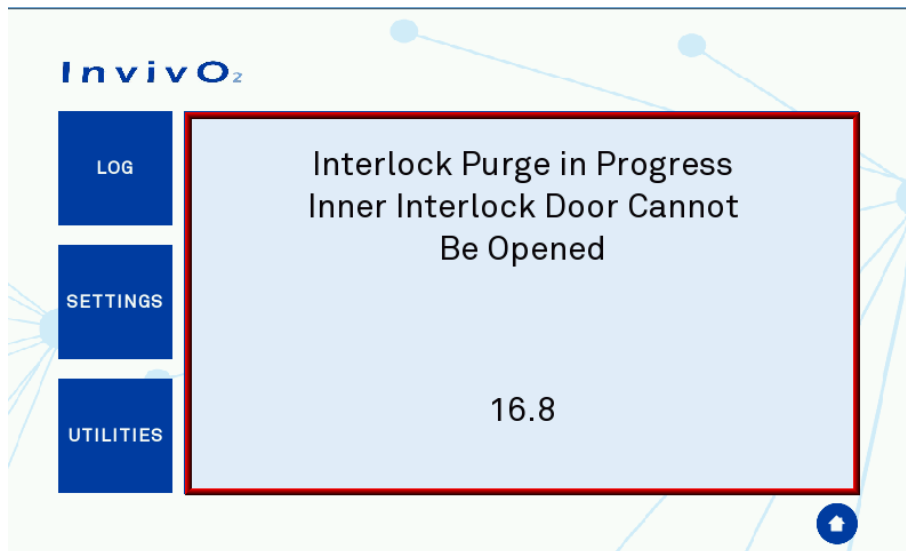

Screen 2: Interlock Purge Timer

- Access the workstation chamber via the Ezeeyin glove ports after putting your arm through the Ezee-Sleeves.
- When the interlock purge cycle has completed, indicated by the touchscreen and the inner door push buttons will be illuminated, then press the inner door button.
- Slide the interlock inner door backwards to open the interlock door.
- Move the material from the interlock chamber into the workstation chamber. The interlock floor tray will slide into the workstation to allow for easier transfer of all of the cells / samples.
- Close the interlock inner door by sliding the floor tray back into the interlock and the interlock inner door forward.

Note: once the interlock has been purged both inner door push buttons will be illuminated and either one can be opened for sample loading. If you wish to transfer materials between workstations, you will be able to load material in from one side, close the interlock door on that side and then open the door on the other side

Removing material from the workstation chamber via the interlock

To remove material from the workstation chamber via the interlock;

- Open the interlock inner door by pressing the inner door button and sliding the interlock inner door backwards.
- Move the material from the workstation chamber into the interlock chamber.
- Close the interlock inner door by sliding the interlock inner door forwards.
- Exit the workstation chamber via the Ezeeyin glove ports.
- Open the interlock outer door.
- Pull the interlock tray towards you.
- Remove the material from the interlock chamber. Do not place object(s) on the interlock outer door, as this may damage the workstation.
- Push the interlock tray into the interlock chamber.
- Close the interlock outer door.

Hand access to the main chamber

Direct hand access to the workstation chamber is provided via the Ezeeyin glove ports and Ezee-Sleeve

The Ezee-Sleeve consists of a gloveless gas tight sleeve and a cuff.

- The Ezee-Sleeve attaches to the glove port via two O-rings.

Note: The workstation should not be used without the Ezee-Sleeve or EzeeCuff attached.



Figure 9: Ezee -Sleeves

Vacuum Operation

To ensure that no external atmosphere contaminates the workstation, a single vacuum operation is required before Glove Port access. To minimise the time, it is recommended to eliminate as much external atmosphere from the Ezee-Sleeve as possible prior to arm entry. This can be achieved by compressing the Ezee-Sleeve before inserting the hand and arm as shown in Figure 10

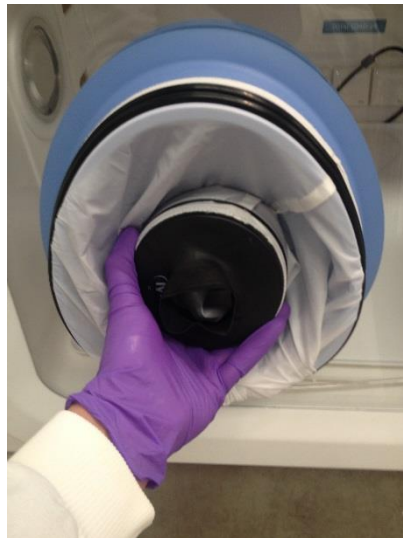

Figure 10: Compressed Ezee-Sleeve for Entry

- Hold the desired Ezee-Sleeve cuff with the opposite hand.
- Support the Ezee Cuff, push the hand through the cuff of the Ezee -Sleeve.
- Insert the arm and grasp the Glove Port handle in preparation for the vacuum stage, using the foot pedals.

Note: Failure to grasp the Handle at this stage will make grasping it after the vacuum operation much more difficult.



Figure 11: Arm inserted into Ezee-Sleeve (Shown with and without Ezee-Sleeve)

While the arm is grasping the handle, generate a vacuum by operating the foot pedal for the corresponding glove port.



Figure 12: Foot pedals for right and left glove ports

The vacuum operation should be continued until the maximum amount of external atmosphere has been removed from the Ezee-Sleeve and the Ezee-Sleeve exerts some pressure on the arm/hand.

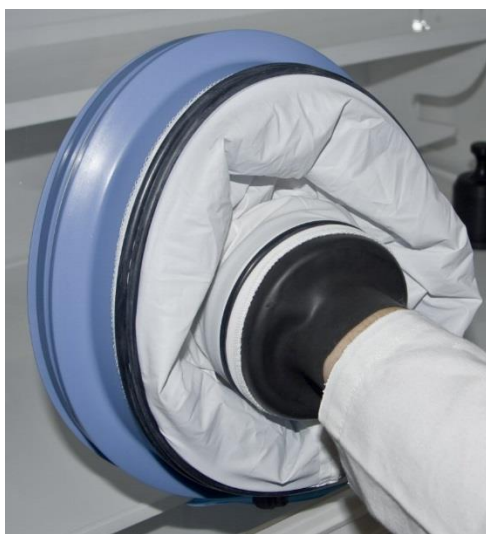

Figure 13: Ezee-Sleeve before vacuum



Figure 14: Ezee-Sleeve after vacuum

The Ezee-Sleeve should pull forcefully against both the inner surface of the Glove Port interior and the users arm and hand when adequate vacuum has been achieved.

Workstation Entry

Once the vacuum has been achieved, the Glove Port Handle can now be rotated in either direction to unlock the Glove Port Cap.

As there is a strong vacuum within the Ezee-Sleeve, removal of the Cap can require a reasonable amount of force. This can be made easier by pushing the uppermost part of the Handle to first break the vacuum at the upper edge of the Cap seal.



Figure 15: Glove port cap

The Glove port Cap can now be stored inside the workstation using the locator feature on the rear of the Cap. These slot into the storage brackets mounted within the workstation.



Figure 16: Glove port cap stowage and locator



Figure 17: Glove port cap storage location inside workstation

Repeat the procedure for the other hand (if both hands are entering the workstation chamber).

Workstation Exit

Remove Cap from storage brackets, and ensure the handle is oriented in a vertical position on the Cap. The Handle is designed with “indexing” detent features to help locate the Handle relative to the Cap.

Drawing the handle into the Glove Port, replace the cap, using the location posts and graphic to orient the Cap correctly on the Glove Port.

Note: Care should be taken to ensure that the Ezee-Sleeve material does not become caught between the Cap and the Glove Port seal.



Figure 18: Glove port cap

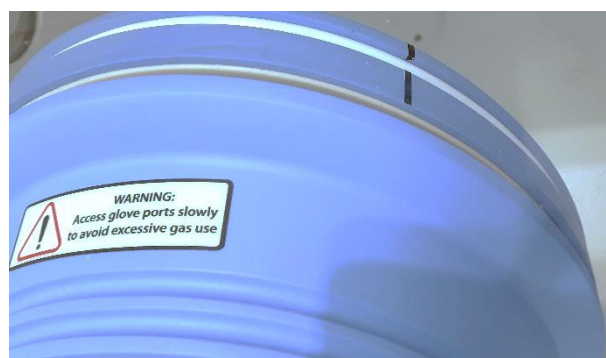

Figure 19: Glove Port Locator

Rotating the Handle by 90 degrees to the horizontal position will now lock the Cap to the Glove Port, allowing withdrawal of the users arm from the Ezee-Sleeve.

Humidity Control

The InvivO₂ workstations control the humidity of the workstation chamber from ambient to 85% relative humidity.

Note: Any equipment installed in the workstation chamber must be suitable for the humidity level inside the workstation chamber. If in doubt, consult the manufacturers' datasheet or manual for any equipment that is installed in the workstation chamber. Ruskinn Technology Limited accepts no responsibility for damage to any equipment installed in the workstation chamber that is not suitable for the conditions inside the workstation chamber.

Aquasorb Sachets

***supplied with workstations that do not have Ultrasonic Humidity option**

These sachets contain a small amount of a super absorbent polymer that has the ability to absorb 500 times its weight in water that is then evaporated into the workstation atmosphere. The workstation allows the humidity to rise to a user defined maximum at which point it will start to strip the excess humidity away at a control accuracy of +/-6%. One sachet should deliver a humidity level of at least 70% for more than 3 days.

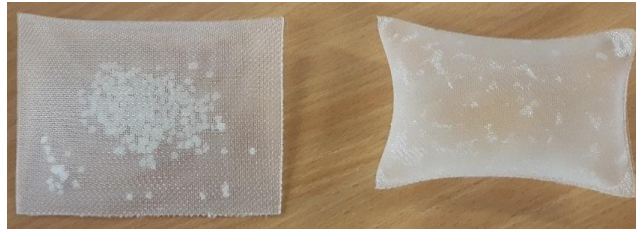

Figure 20: Aquasorb Sachets - Empty and Charged

The sachets are supplied 'dry' and require charging before use by placing the sachet in the tray provided with them and filling with deionised water. The sachet will expand as it absorbs the water to fill the volume of the sachet. Once complete, lightly shake and/or wipe off any excess water droplets and then place in the workstation on the metal tray. The sachets can be 'recharged' multiple times and are capable of continuous use for a number of months if kept clean. It is up to the end user to decide on the frequency of replacement but we recommend every month or two to change the sachet. Additional sachets can be purchased from Ruskinn or your local distributor.



Figure 21: Aquasorb Sachet in Workstation

Ultrasonic Humidity (Optional)

The ultrasonic humidity option for the InvivoO₂ 1000 Dual workstation allows full control of the working humidity level in the workstation. The humidity level is controlled to $\pm 3\%$ of the set point to ensure that the required humidity level is maintained.

The system has a large water tank as the supply for the humidity and should be filled with only deionised water to maintain the cleanliness of the system. The water from the tank is then passed through a filter to ensure that there is no contamination of the water supply to ultrasonic nebuliser.

Water Tank

The water tank is included as part of the ultrasonic humidity system.



Figure 22: Humidity System Water Tank

The workstation monitors the water level in the tank through a level sensor and will identify when the water tank needs re-filling. When filled to the MAX level, the water tank should last approximately 4-5 days at 70% RH at a steady gas level.

An alarm warning will appear on the touch screen to notify a Low Water condition, and if this is dismissed the following icon with flash on Screen 9



Icon 2: Humidity Low Alarm

The water tank is removable for cleaning, or replacement if required. To remove the water tank first unscrew the three thumb screws holding the water tank in place:



Figure 23: Water Tank Thumb Screw

Once these are removed the water tank can be lowered in the end panel to expose the top of the tank, then tilting the top forward will allow access to an electrical connector and a blue that need to be disconnected from the top .



Figure 24: Water Tank lowered for removal



Figure 25: Water Tank tilted forward partially removed



Figure 26: Water Tank top tube removal



Figure 27: Water Tank electrical connector



Figure 28: Water Tank bottom lifted out

Once raised out there is an additional tube to remove from the bottom of the tank. Tilt the water tank so that the level of the remaining water is below the tube connector to avoid spillage as the tube is removed.



Figure 29: Water Tank bottom tube disconnection

Re-installation is carried out reversing the removal procedure. Once the humidity system is switched back on the water pump may activate for a short time to replenish the water in the nebulisation tank in the workstation and re-prime the tubing.

Condensate Plate

If there is excess humidity in the system, or you want to run a 'dry' atmosphere then the condensate plate is able to reduce the humidity level. This is achieved by cooling the plate to below the dew point to allow for the humidity to condense on the plate.

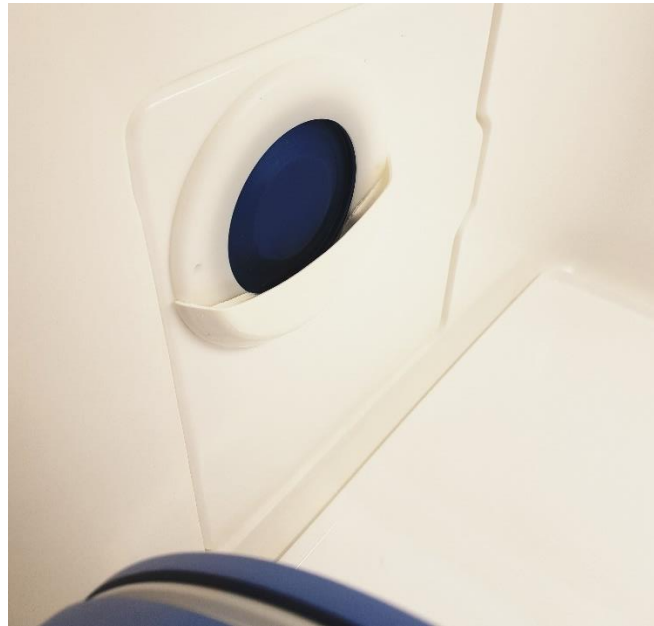

Figure 30: Condensate Plate

As this forms droplets these are then collected into a small reservoir in the end panel that will then drain off when it fills to a pipe at the rear of the workstation.

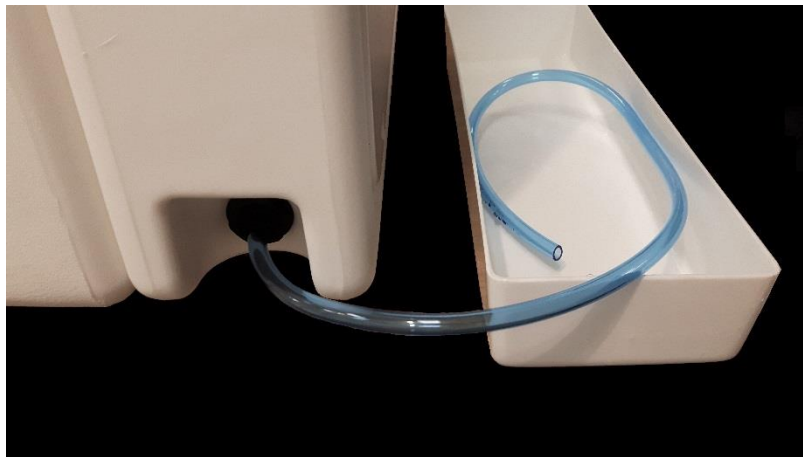

Figure 31: Condensate Output and Tray

A water tray is provided to collect the water for disposal or it can be piped to a drain if located close by.

SCREENS

Main screen

When the unit is first powered on a Ruskinn Logo screen will appear and will be replaced by Screen 3

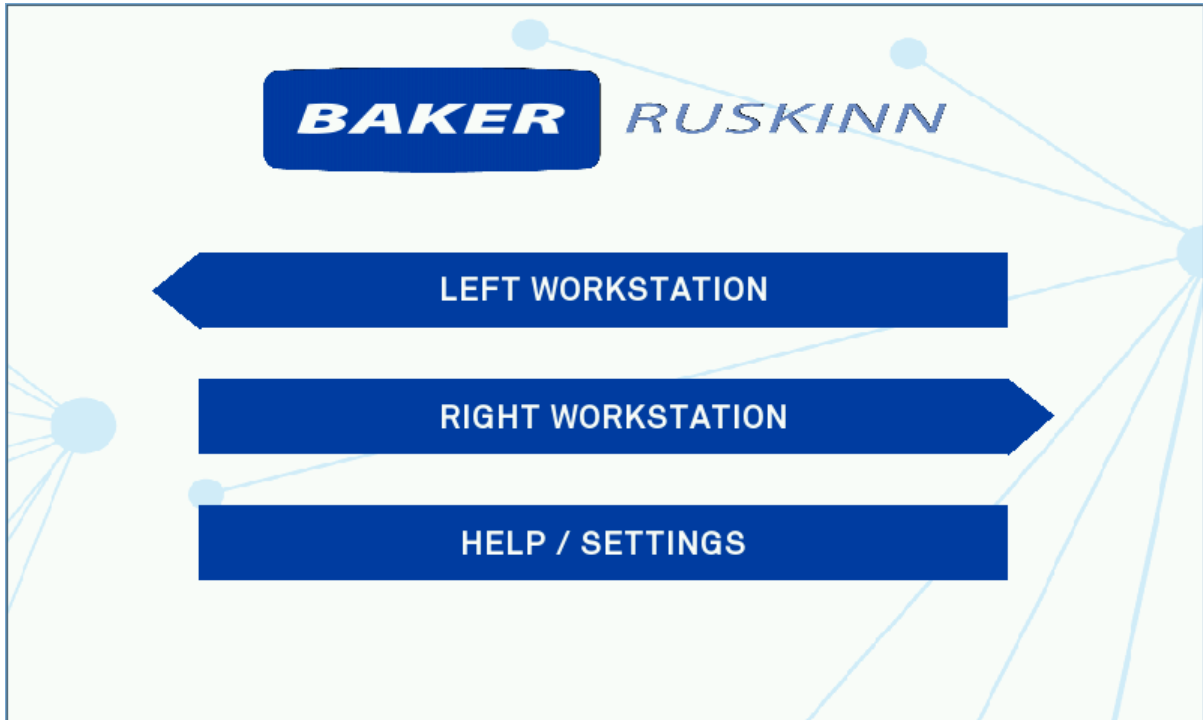

Screen 3: Workstation Selection

From this menu you will be able to access all of the features of both workstations.

Selecting the Left workstation will bring up Screen 4: Left Main Menu and selecting the Right workstation will bring up Screen 5.

Both workstations have the same control screen layouts other their respective main menus

Left and Right Workstation Main Menus



Screen 4: Left Main Menu



Screen 5: Right Main Menu

The arrows on either side of the menu indicate which workstation is being controlled. Pressing the Home icon will return to the workstation selection screen

InvivO₂ Initial Settings Screen

Pressing the “Atmosphere Control” bar on Screen 4 or Screen 5 will open up the settings screen shown in Screen 6.

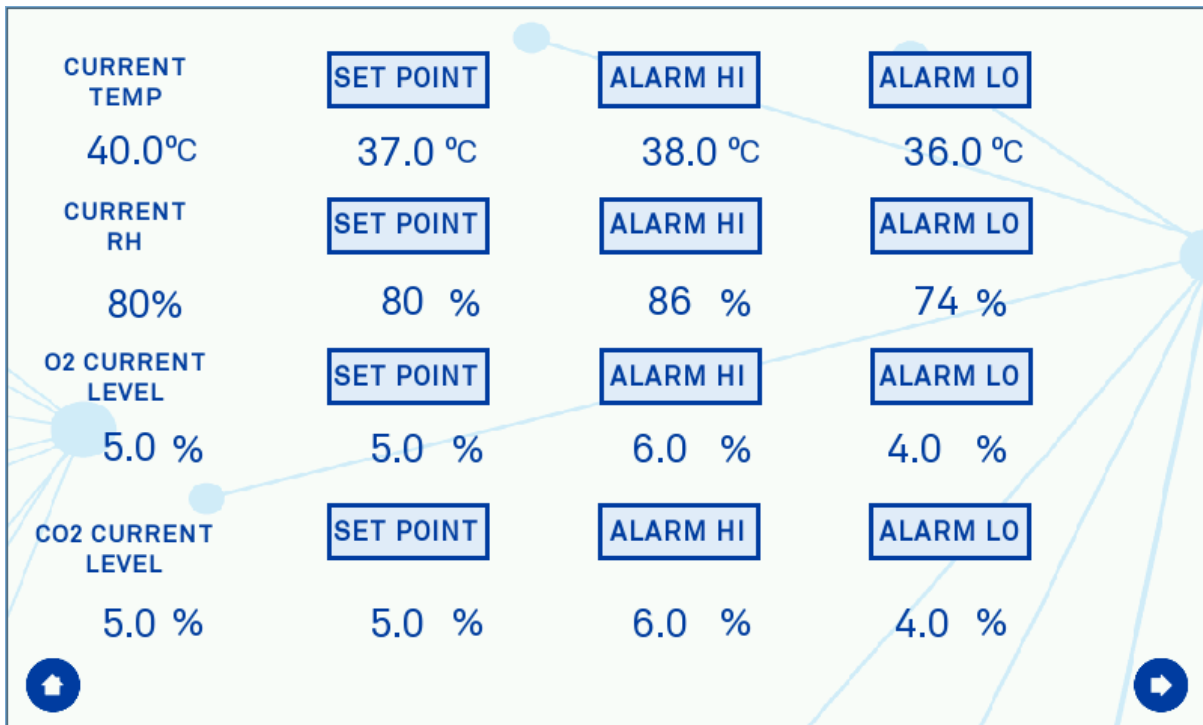

Screen 6: InvivO₂ Initial Settings Screen with Ultrasonic Humidity Option

Viewing the rows from left to right they display:

Row 1	Row 2	Row 3	Row 4
Measurements	Set-Points	High Alarm Levels	Low Alarm Levels

Table 6: Settings screen column functions

Rows 2, 3, and 4 can be changed by the user by pressing on the value and a pop-up will appear for the new setting to be selected, as shown in Screen 7 for the Oxygen set-point change



Screen 7: Oxygen Level Set-point Pop-up

Once all of the set-points are correct then pressing the arrow in the bottom right of the screen will start the gas control.

Pressing the ‘Home’ button on the bottom left will return to the main menu.

If the workstation does not have the ultrasonic humidity option fitted then the humidity set point is can be adjusted in increments of 5% using the arrows. The software will then allow the humidity to rise to this value and limit the maximum internal humidity.

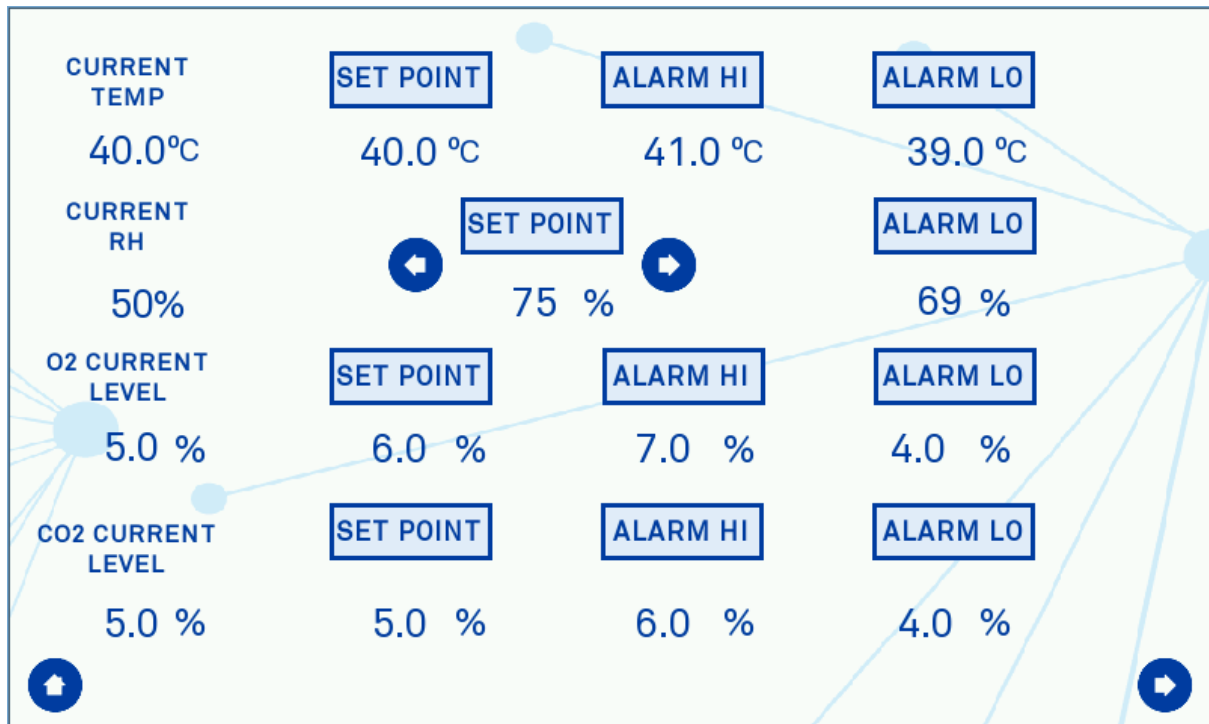

Screen 8: Initial Settings Screen with Aquasorb Humidity

Environment Control

The Environment Control screen is the main screen during use to monitor the current workstation conditions and gain access to all of the in-use functions.

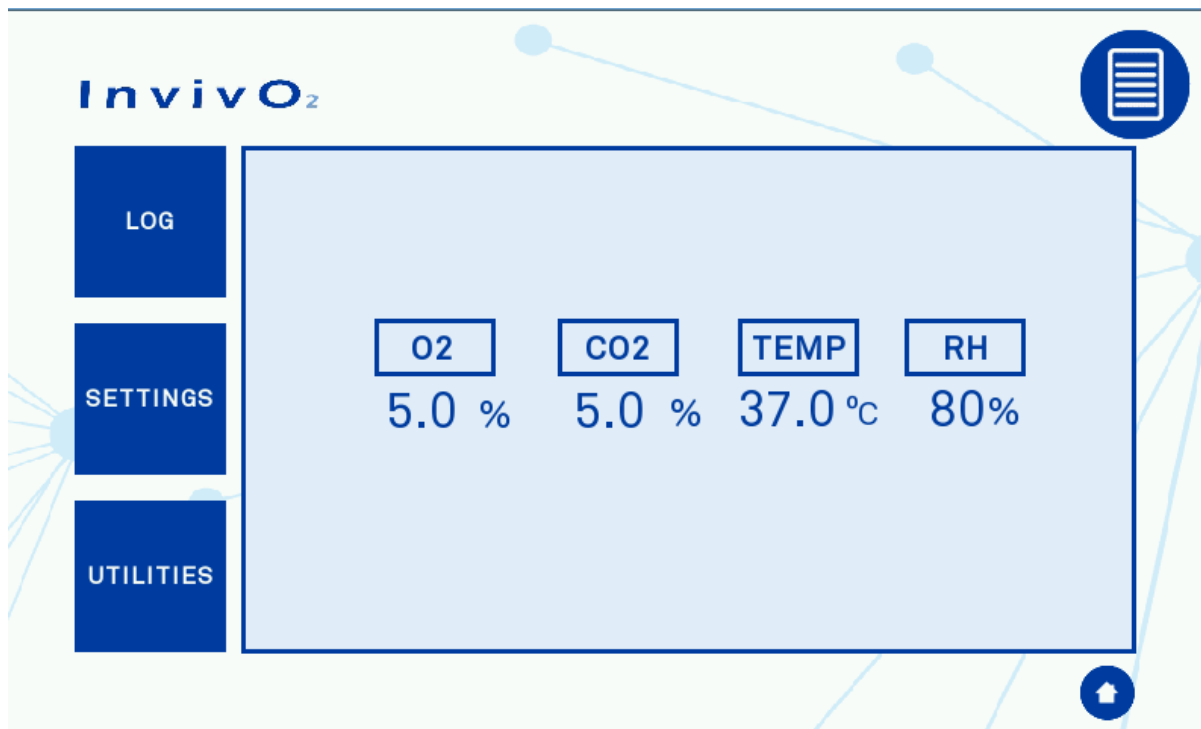

Screen 9: Environment Control Overview

Pressing the home icon on the bottom right will bring up Screen 10 to stop gas control and return to the main menu

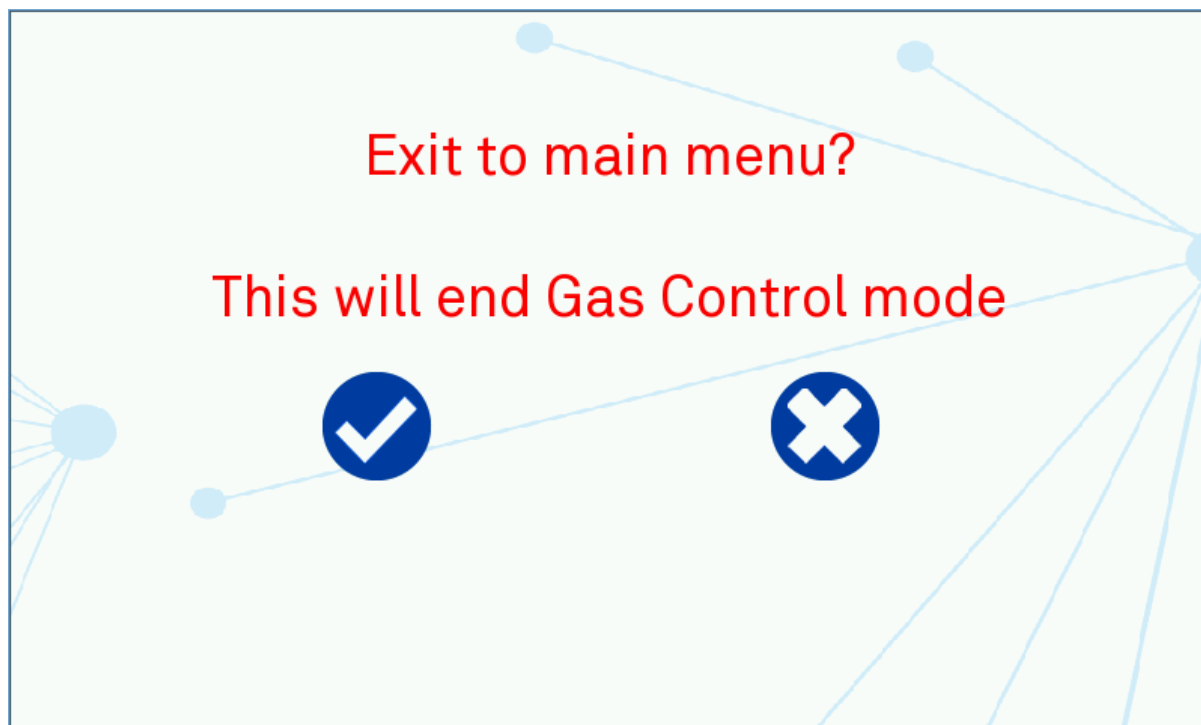

Screen 10: Exit Gas Control Warning

Workstation Overview

The workstation overview screen displaying the status of both workstations can be accessed by pressing Icon 3 on either sides Screen 9.



Icon 3: Workstation Overview

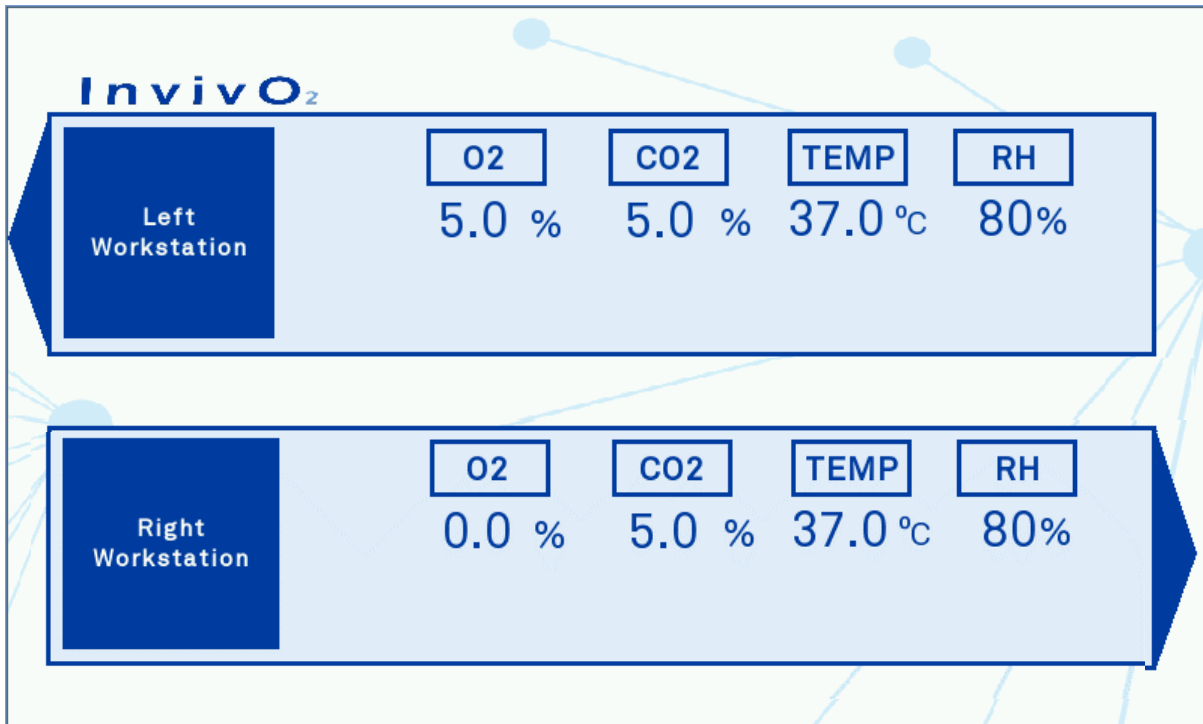

Screen 11: Workstation Overview

The environment control screens can be accessed by pressing the “Left Workstation”, or “Right Workstation” buttons.

If only one side of the workstation is in use and the overview screen is selected then the side that is not being used will display the following:



Screen 12: Workstation Not in Use

Workstation Switching

Workstation Environment Control Screens Overview

Figure 32 provides a quick overview of the screen flow for both sides of the workstation.

Note: the Hypoxic control has only been shown for the left workstation but is available for both.

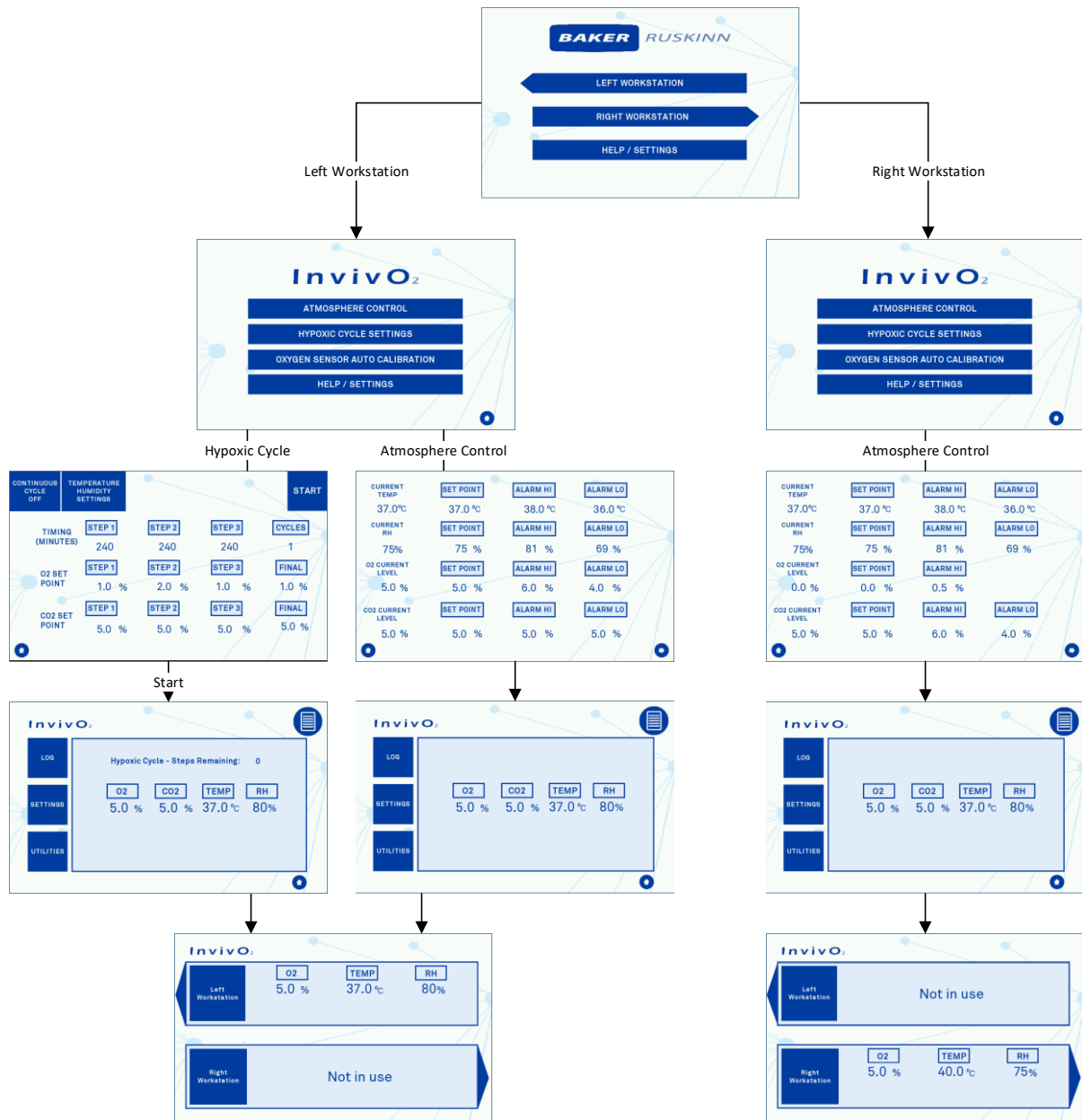
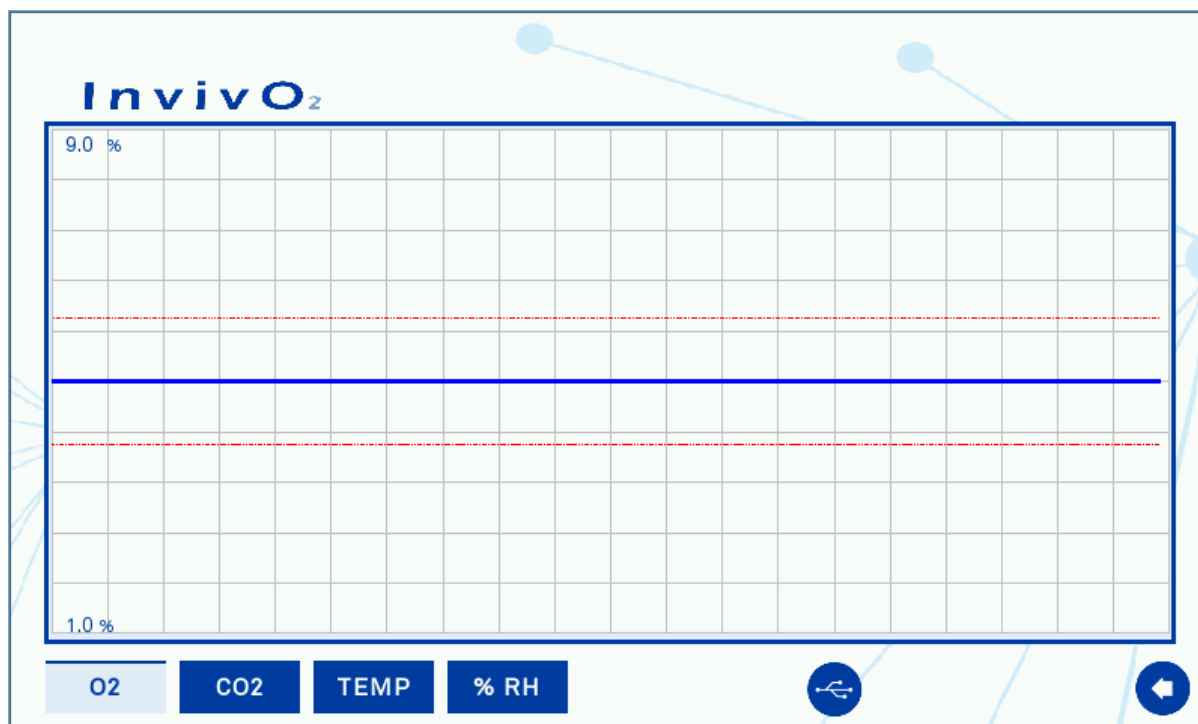

Figure 32: Workstation Environment Control Screens Overview

Data Logs

The Data Log screens can be accessed from the button on Screen 9 and will give four options of trends to view as well as the option for the safe removal of the USB memory stick.



Screen 13: Trend Log

Pressing the values on the graph at the top and bottom left will open up a pop-up similar to Screen 7 to allow the scale of the graph to be changed within the Min/Max limits shown at the top of the box.

The red horizontal lines show the current Alarm levels from the settings screen to easily see if there have been any deviations outside of the required operating parameters.

Pressing the USB logo button will perform a safe removal of the USB memory stick to allow for data transfer to a PC. It is recommended that the USB memory stick is kept in the workstation at all other times to make sure that the data is recorded. For details of the contents of the Trend Log please see the USB Trend Log section.

The back arrow will return to Screen 9 for the Gas Control overview.

Utilities

The Utilities Menu is accessible from Screen 9 for Gas Control.

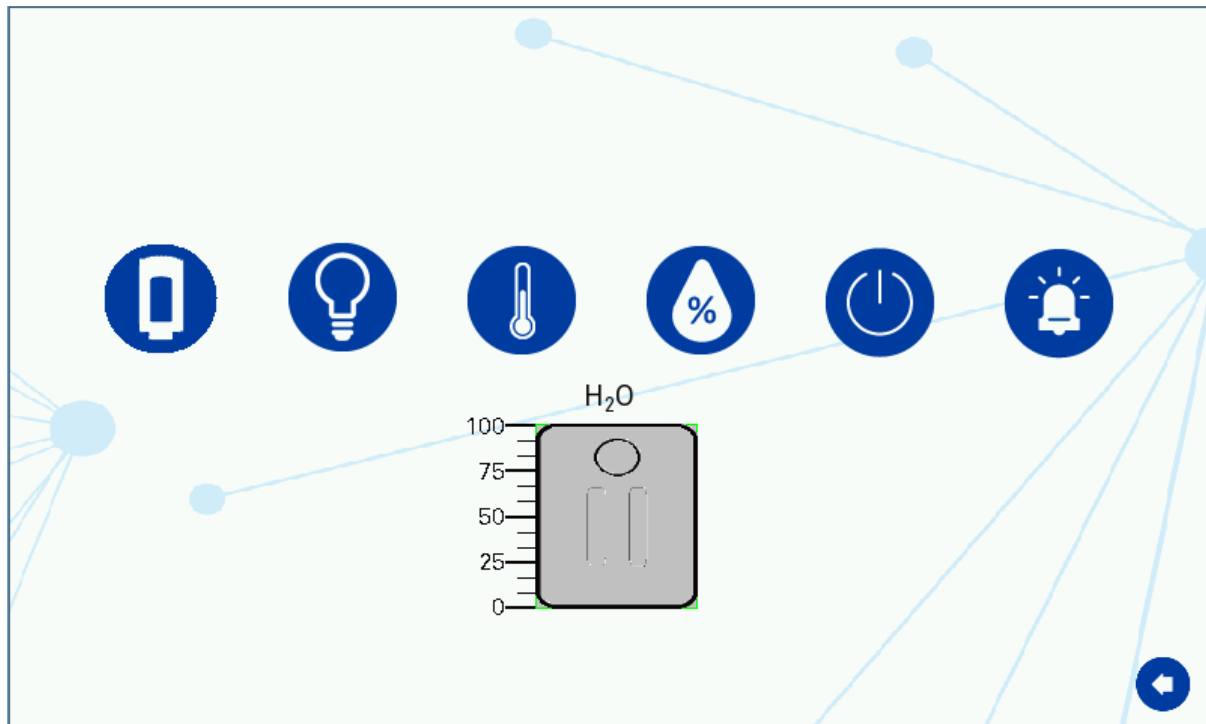

Screen 14: Utilities Menu

The six buttons that control the following functions from Left to Right. Light blue backgrounds indicate the function is on, dark blue for off:

- Button 1, Outer Interlock Door Open. This will release the interlock door when the button is pressed for > 3 seconds.
- Button 2, Internal Lights. This will open a separate pop-up, Icon 4. The icon on the left turns the light on/off and the bar will adjust the brightness of the lights in the main work area. This bar can either be slid into position or tapping on the setting required.



Icon 4: Internal Lights Control

- Button 3, Temperature Control on/off.
- Button 4, Humidity Control on/off. (For Ultrasonic Humidity Option Only)
- Button 5, Internal Sockets on/off.
- Button 6, Audible Alarm on/off. This turns the warning buzzer off with a red cross through it.

The image at the bottom of the screen represents the water tank for workstations with Ultrasonic Humidity fitted. The water level in the tank is displayed on the screen so you can see easily when the water tank will need refilling.

Hypoxic Cycle

The Hypoxic Cycle menu is accessed from Screen 3 to allow for dynamic changing of the Oxygen and Carbon Dioxide levels over fixed time periods. The initial setting is for continuous cycling for up to 3 set-points.

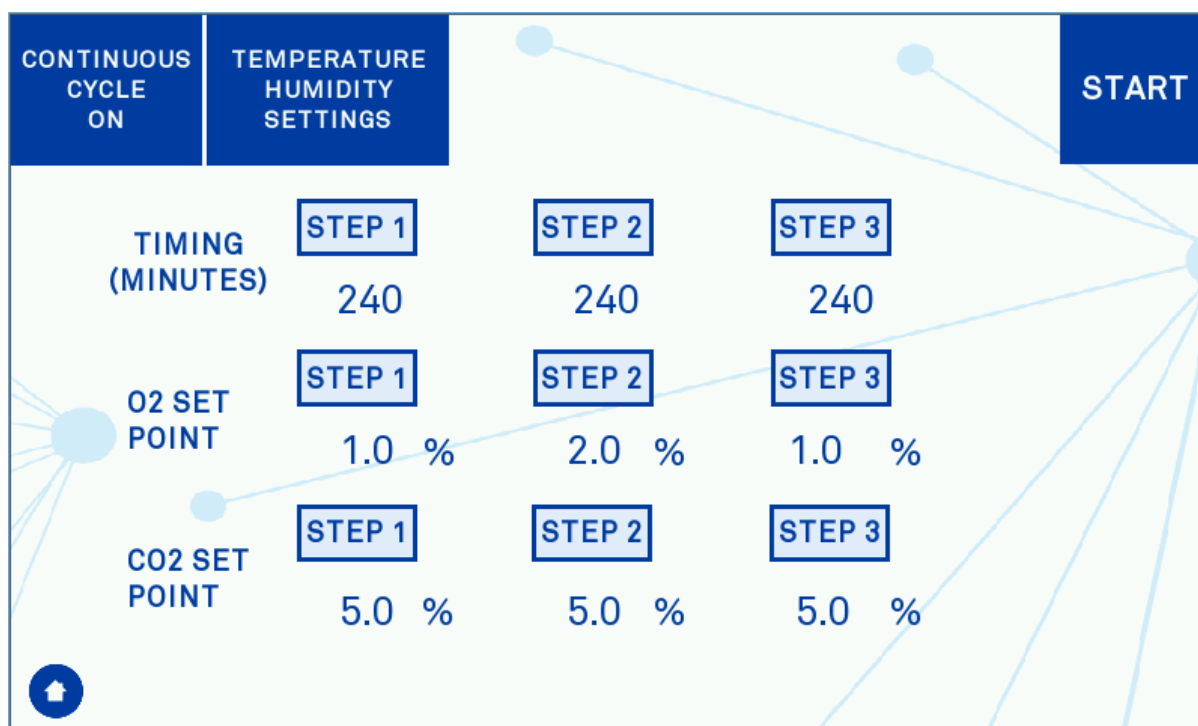

Screen 15: Hypoxic Cycle Menu - Continuous Cycle On

The timing values define how long the Oxygen and Carbon Dioxide levels are maintained for once they have been achieved. This means that there is a time period between the steps that is not able to be set as it is dependent on the difference between the set-points within the gas control software.

Pressing on any of the values will bring up a dialogue box to enter in the required setting. If only 2 values are required for the cycling then set step 1 and 2 as required, then set step 3 time period to 0 minutes with the O₂ and CO₂ set-points the same as step 2.

Once the settings are correct then press the start button to begin the cycling. At this point the start button will change to a spot button. The continuous cycling will stop by pressing the Stop button or by pressing the home icon to return to the main menu.

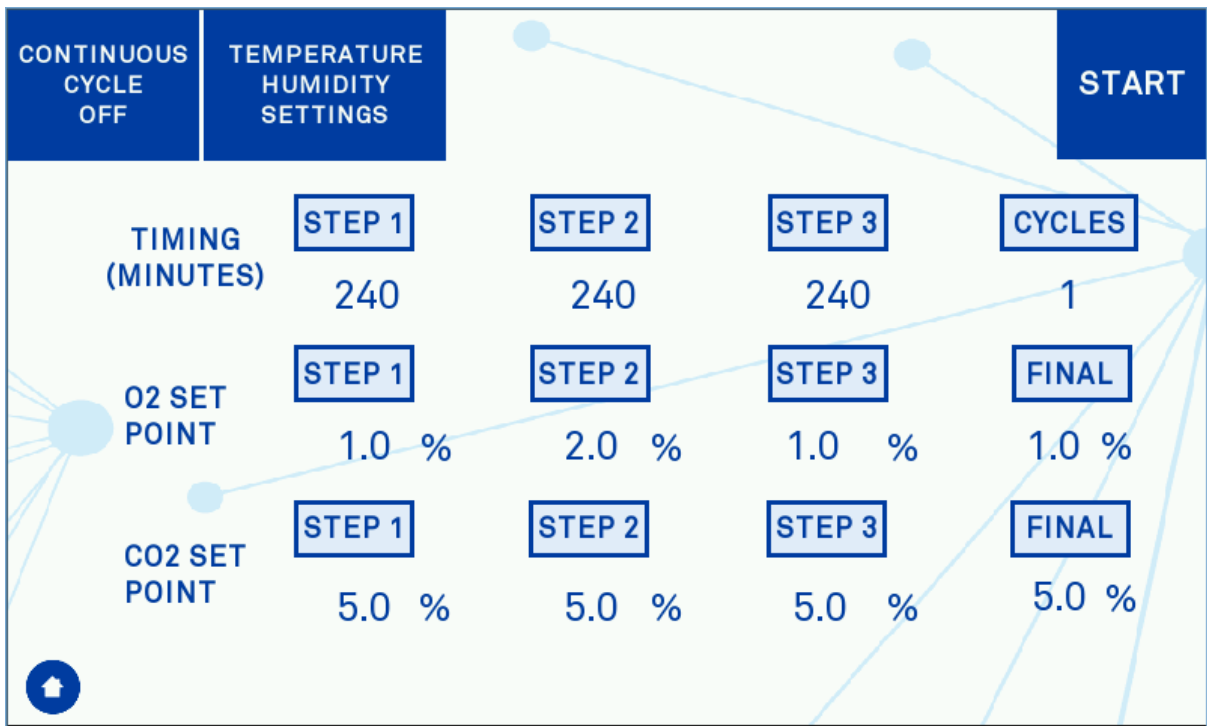

Screen 16: Hypoxic Cycle Menu - Continuous Cycle Off

If you require a finite cycle sequence then pressing the Continuous cycle button will toggle it to Off and bring up some additional settings.

As with the continuous cycle you are able to select up to 3 different set-points with a time to remain at each, and if you only want 2 set-points to can set step 3 to 0 minutes and copy the set-points from step 2.

There is also the option to set how many cycles you complete before the workstation finishes the cycling with the Final set-points.

The cycling can be stopped at any time by pressing the stop button or the home icon.

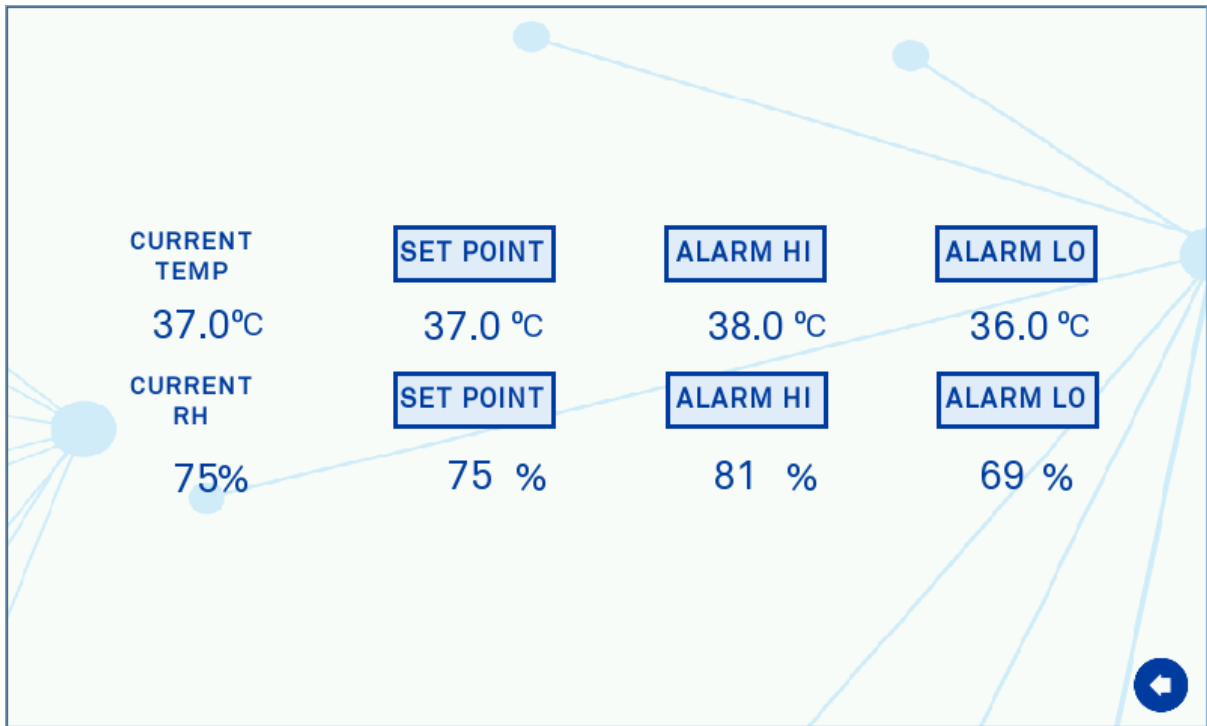

Screen 17: Hypoxic Cycle Temperature and Humidity Settings

Within the Hypoxic Mixing cycles the workstation will maintain the temperature and humidity settings. These settings are accessed from the button on Screen 15 or Screen 16 and operate in the same way as Screen 6. **Error! Reference source not found.**

Oxygen Sensor Calibration

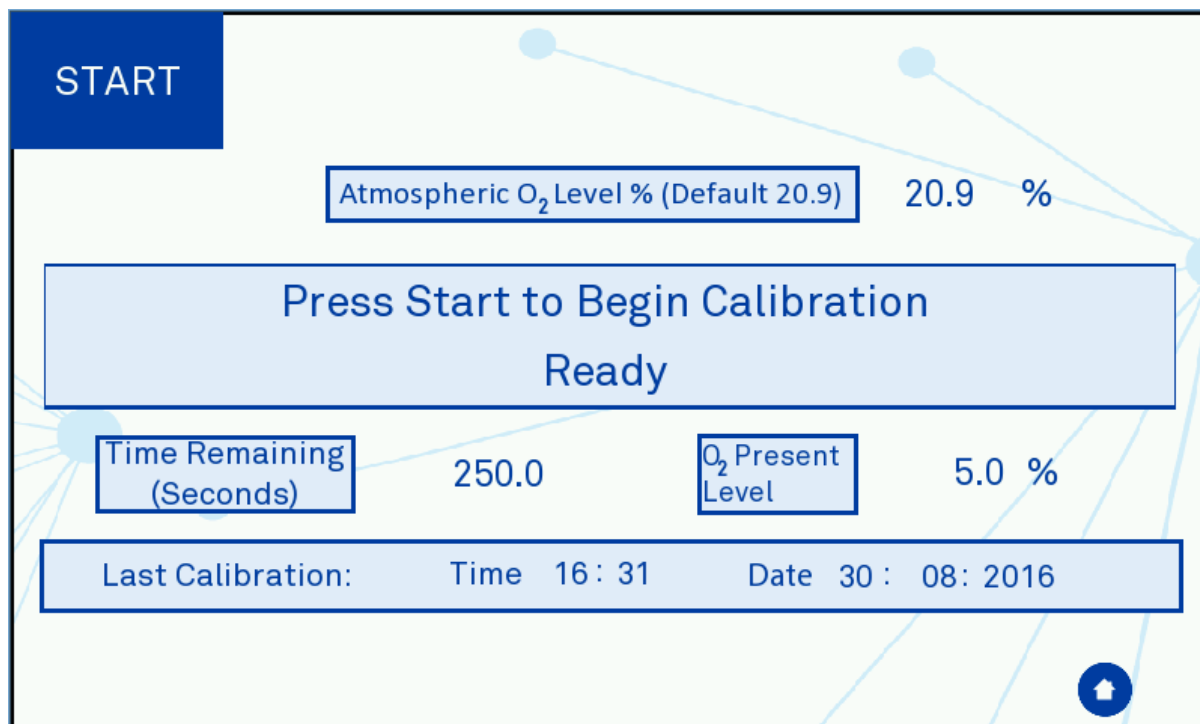

Screen 18: Oxygen Sensor Calibration

The Oxygen sensor calibration screen can be accessed from the main menu for periodic calibration. The calibration procedure uses the Nitrogen supply to determine the low (0% Oxygen) operation point and the ambient atmosphere for the high operation point. The Atmospheric Oxygen level is set to 20.9% as default but this can be changed if required. Once this setting is entered to the correct level, pressing the start button will begin the automatic calibration procedure and the time remaining will start decaying to zero. Once the calibration procedure is complete the Oxygen sensor will then re-settle to the current workstation environment level.

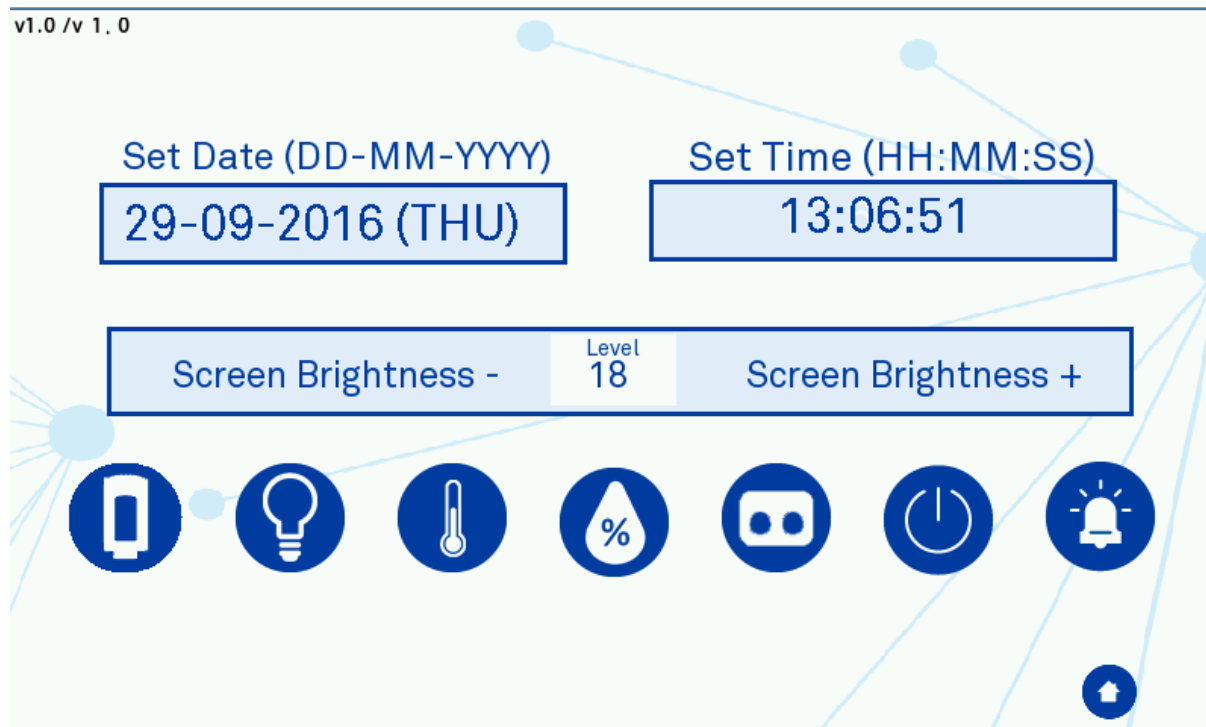

Screen 19: Help / Settings Menu

In this menu you are able to adjust the time and date by pressing on the current setting and a pop-up window will appear to enter the new setting.

The screen brightness can be adjusted between 0 (Dim) and 30 (Bright) in increments of 3 giving 11 brightness levels.

There are up to seven icons along the bottom of the screen. Light blue backgrounds indicate the function is on, dark blue for off:

- Button 1, Outer Interlock Door Open. This will release the interlock door when the button is pressed for > 3 seconds
- Button 2, Internal Lights. This will open a separate pop-up shown in Icon 4. The icon on the left turns the light on/off and the bar will adjust the brightness of the lights in the main work area. This bar can either be slid into position or tapping on the setting required.
- Button 3, Temperature Control on/off.
- Button 4, Humidity Control on/off. (For Ultrasonic Humidity Option Only)
- Button 5, Front Screen Release (Pop-off optional accessory). This will open the exhaust valve to release the positive pressure in the workstation and then de-active the seal around the front screen for removal
- Button 6, Internal Sockets on/off.
- Button 7, Audible Alarm on/off. This turns the warning buzzer off with a red cross through it.

Warnings

There are various warning screens and icons to draw the user attention when required.

Temperature Alarm

This screen will appear if the workstation temperature is not at the set-point. This will appear during the initial turn-in or if the set-point has been changed by more than 0.2°C. The alarm can be dismissed by pressing the return arrow at the bottom right of the screen. If the workstation still has not reached set-point within 20 minutes then the alarm screen will return. If the alarm screen is not dismissed manually it will automatically be cancelled if the workstation reaches set-point.



Screen 20: Temperature Alarm Screen

Water Level Low Alarm – Ultrasonic Humidity Only

If the humidity system is turned on and the water level in the water tank falls too low then the following warning screen will appear. This can be dismissed by pressing the back arrow at the bottom right but it will appear again if the water level is still too low after 20 minutes. If the water tank is re-filled then the alarm will automatically clear. This alarm can also be cleared if the humidity system is turned off but will result in uncontrolled levels of humidity in the workstation.

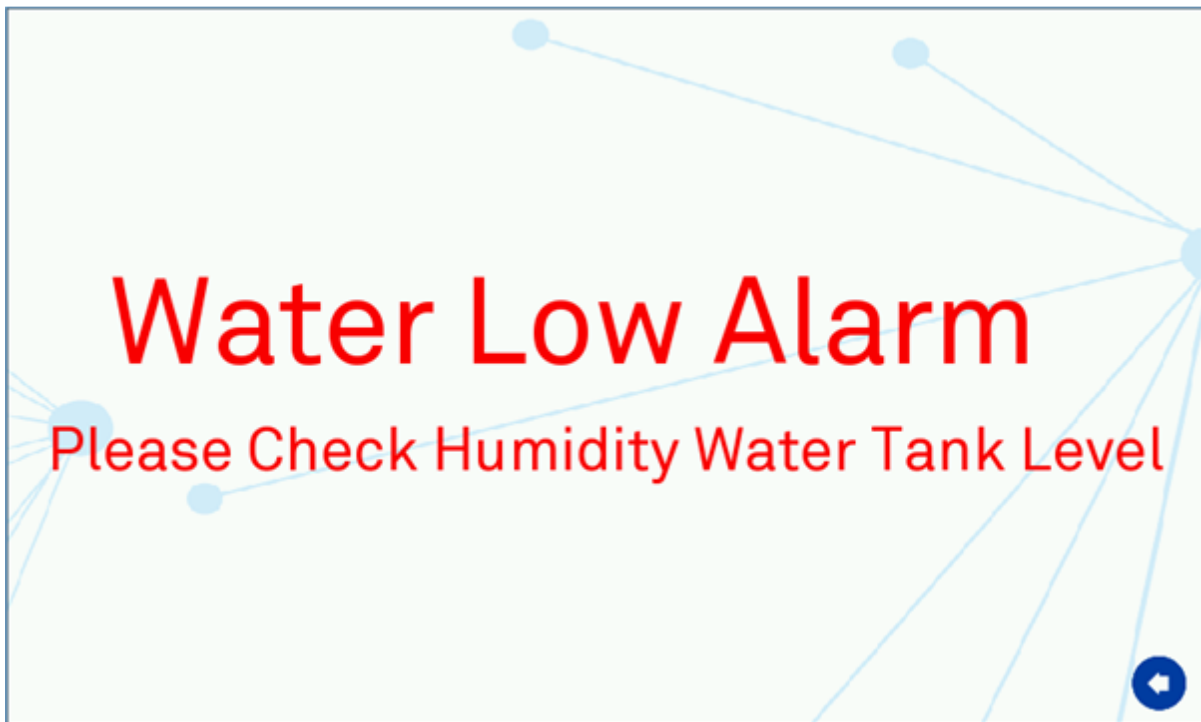

Screen 21: Water Tank Low Warning Screen

USB Alarm

The USB alarm will activate if the USB memory stick has been removed for longer than 5 minutes as a reminder to replace it after the log files have been copied to a computer for analysis. This alarm can be dismissed by pressing the back arrow at the bottom right of the screen for 5 minutes and then it will re-activate.



Screen 22: USB Memory Warning Screen

Set-Point Failure Alarm Screen

This alarm activates if the gas set-points have not been reached with 3 hours of mixing. This will also disable the gas control of the workstation to avoid excessive gas usage as it indicates an issue with the gas tightness of the workstation.



Screen 23: Gas Mix Time Limit Warning Screen

The alarm can be dismissed by pressing the back arrow at the bottom right of the screen. Once this has been done please check the procedure in the section 'Excessive Gas Usage' for checking the gas integrity of the workstation.

Input Gas Pressure Alarm

This screen will appear when the pressure on the required gas lines fall below the required minimum levels as defined in the Gas Supply Requirements section. Please refer to the section " for common problems and solutions

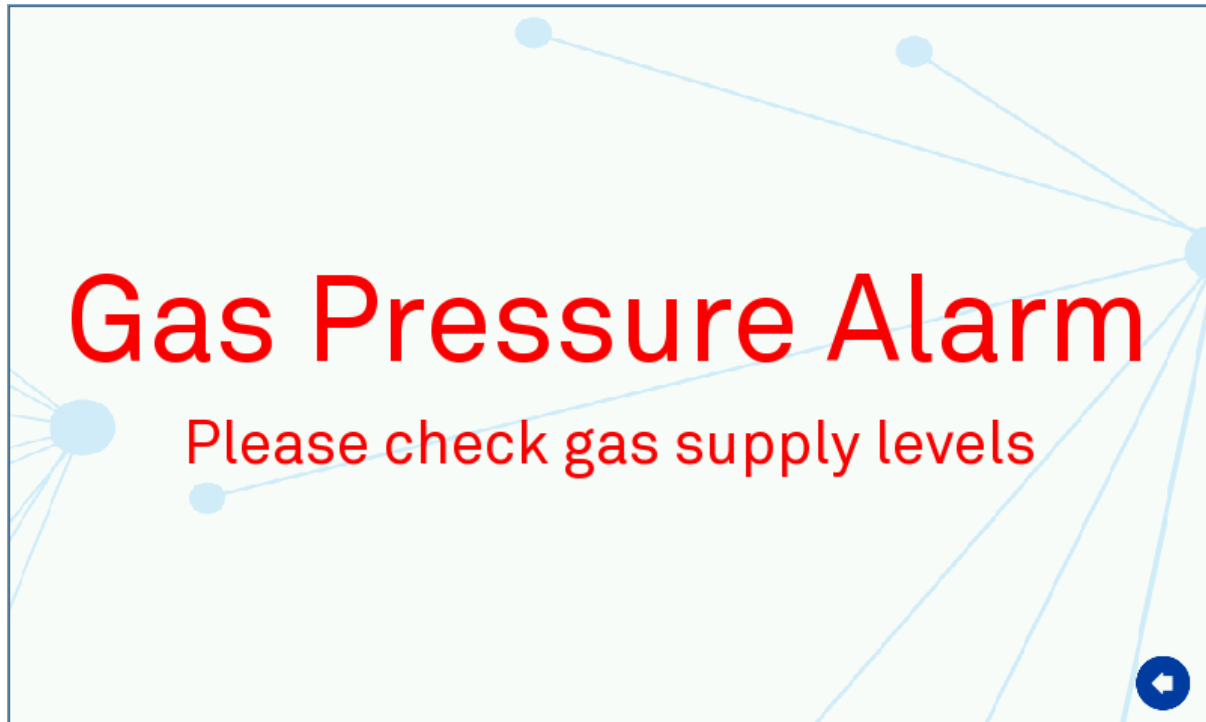

Screen 24: Input Gas Pressure Alarm

Alarm Purpose	Alarm Buzzer Sound
Temperature Alarm	1 second Pulse On/Off
Input Gas Pressure Alarm	Continuous Tone
Water Level Low Alarm*	Continuous Tone
USB Alarm	1 second Pulse On/Off
Set-Point Failure Alarm	Continuous Tone

Table 7: Audible Alarm Sounds

*Only available with optional Ultrasonic Humidity System

USB TREND LOG

The Trend Log is updated onto the USB memory stick every minute to enable to data to be downloaded and analysed as required. Note that the USB memory stick must have a FAT32 format to store the data and that the memory stick should be directly connected to the port without the use of USB extension leads.

The Trend log stores the following information:

Default Header	Channel Data Heading	Data Description
TIME	TIME	Time of recording in hh:mm:ss format
CH0	O2 Actual	Measured Oxygen Concentration
CH1	O2 Set-Point	Oxygen Concentration Set-point
CH2	CO2 Actual	Measured Carbon Dioxide Concentration
CH3	CO2 Set-Point	Carbon Dioxide Concentration Set-point
CH4	O2 Deadband	Oxygen Deadband
CH5	CO2 Deadband	Carbon Dioxide Deadband
CH6	O2 DB Count	Oxygen Deadband Counter (Time in Deadband in minutes)
CH7	CO2 DB Count	Carbon Dioxide Deadband Counter (Time in Deadband in minutes)
CH8	Temp Set-Point	Temperature Set-point
CH9	Chamber Temp Actual	Chamber Temperature Measurement in °C
CH10	Water Tank Level	For workstations with Ultrasonic Humidity this is the water level remaining in the Water Tank
CH11	Interlock Temp Actual	Interlock Tray Temperature Measurement
CH12	Humidity Actual	Relative Humidity Measurement
CH13	Humidity Set-Point	Relative Humidity Set-point
CH14	Pressure Switch Count	Time in minutes since the workstation pressured dropped below 0.05kPa
CH15	Pressure Switch Actual	Pressure Switch Measurement in kPa

Table 8: Trend Log Data Fields

Deadband is the control limit for the gas concentrations. The default value for these is 0.2%, meaning that if the set-point was 5% the workstation would control the gas concentration to a value between 4.8% and 5.2%. If the measured gas concentration is outside of these limits then it will start to inject gas to meet the set-point.

If the USB memory stick is removed from the workstation then the measurements for the removed period of time will not be taken. Therefore, it is advised that when downloading the measurement data it is completed quickly to reduce the number of missed measurements.

CLEANING AND SERVICE REQUIREMENTS

Service and Cleaning Overview

To maintain optimal performance of the InvivO₂ workstation it must be serviced at regular intervals. Lists the servicing requirements, intervals and persons capable of performing the service are detailed in Table 9.

Important notice:

Your Baker Ruskinn Workstation includes a 2 year warranty. This is only valid if the first year service is carried out in accordance with table 6 below.

Action	Frequency	By
Clean workstation	After each use	End User
Empty waste port bag	Weekly	End User
Fill humidifier tanks	Weekly	End User
Calibrate oxygen sensors	Monthly	End User
Deep clean workstation	3-6 months	End User
Replace detox sachets	Annually	End User/ Qualified service engineer
Replace catalyst sachets (if used)	Annually	End User/ Qualified service engineer
End User service	1 st and 3 rd Years	End User
Preventative Maintenance Service	2 nd and 4 th Years	Qualified service engineer

Table 9: Cleaning and Service Details

To order end user service kits or to arrange a service engineer visit contact your local distributor. For a service engineer visit please ensure that the unit is in a safe state and decontaminated if required.

To arrange a service contract contact your local distributor.

The correct cleaning agents must be used to clean the workstation. The use of incorrect cleaning agents will damage the workstation and invalidate the warranty. The following cleaning agents are permitted:

- Ethanol, laboratory grade at a maximum concentration of 70% by volume ethanol in distilled water.
- Isopropanol, laboratory grade at a maximum concentration of 70% by volume Isopropanol in distilled water.
- Tristel Fuse Sachet, 1 sachet diluted in 3 litres of distilled water, or Tristel Duo Foamer. Tristel Fuse Sachets and Duo Foamer are available from Ruskin Technology Limited.
- Ruskin Technology Limited anti-static cleaner.
- Distilled or de-ionised water.

No other cleaning agents are permitted.

The use of UV light is prohibited in the workstation as it will cause permanent damage. The use of UV Light within the Workstation will invalidate the warranty.

Cleaning procedure – during and after each use

During use, clean any spills immediately using paper towels soaked in an appropriate cleaning agent. Wipe dry using a dry paper towel.

After each use;

- Remove all waste materials from the workstation chamber(s).
- Wipe the workstation chamber floor tray(s) using paper towels soaked in an appropriate cleaning agent and squeezed to remove excess fluid.
- Wipe the workstation chamber floor tray(s) clean using paper towels to dry.
- Wipe the interlock floor tray using paper towels soaked in an appropriate cleaning agent and squeezed to remove excess fluid.
- Wipe the interlock floor tray using paper towels to dry.

If a waste port is installed then check the waste port bag and replace if full.

Cleaning procedure – deep clean with front screens removed

Preparation:

- Return to a main menu (Screen 4 or Screen 5), enter the settings menu Screen 19
- Open the outer interlock door by pressing Icon 1: Interlock Outer Door for >3 seconds
- Remove the front screen by pressing Icon 5 on Screen 19.



Icon 5: Front Screen Release

- Removing the front screen will disable the internal lights, heating and humidity control.
- Removing the front screen will also activate an audible alarm in all screens other than the main menu.
- The following screen will appear to ensure that the glove port pneumatic connector is disconnected before the screen is removed.

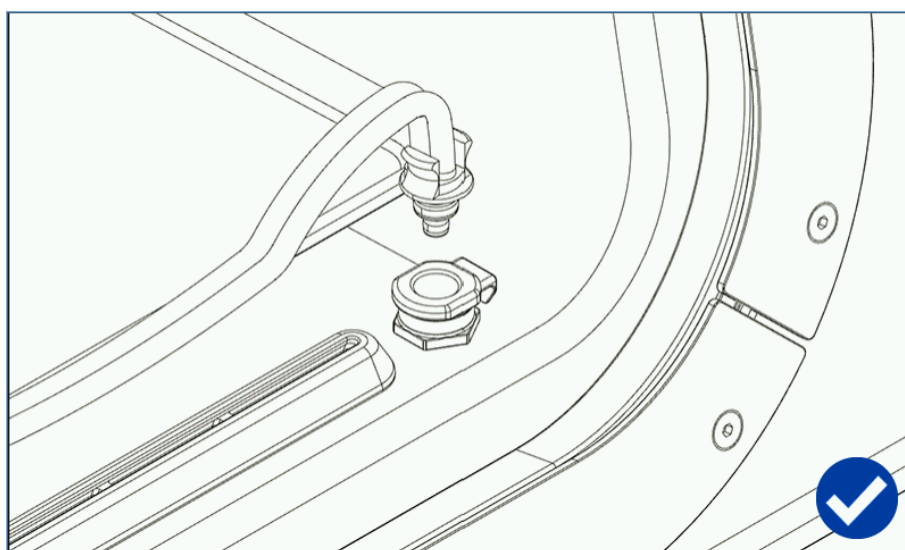

Figure 33: Front Screen Pneumatic Connector Disconnection

- Remove any cells / media and store in an appropriate location.
- Switch off the workstation by disconnecting the mains power cord from either the rear of the unit or from the wall socket.
- Remove the storage racks from the chamber.
- Remove any other equipment installed from the chamber, with the exception of an integrated microscope.
- Remove the workstation floor tray, remove the waste port lid and bag if fitted.

Cleaning:

- The components that require cleaning are;
 - Workstation floors.
 - Workstation side walls.
 - Workstation ceiling.
 - Workstation floor tray.
 - Interlock inner door.
 - Storage racks.
 - Front Screen.
 - Waste port
 - Interlock floor – by sliding the floor tray into the workstation.
 - Interlock side walls.
 - Interlock ceiling.
 - Interlock floor trays.
 - Interlock outer door
- For all workstation components, wipe with a paper towel soaked in an appropriate cleaning agent and squeezed to remove excess liquid. Take care not to get cleaning agents on the mains sockets.
- Wipe dry using paper towels.
- For the front screen ensure that both sides are cleaned.
- Clean any other equipment placed in the workstation following the manufacturer's instructions.

Reinstalling workstation components:

- Place the floor tray inside the workstation chamber.
- Reinstall the storage racks.
- Replace the waste port lid and waste port bag if fitted.
- Reinstall any equipment removed from the workstation chamber.
- Close the outer interlock doors
- Plug the workstation back in at the mains.
- Switch the workstation on.
- Go into the setting menu, reinstall the front screen, activate the seal and connect the glove port pneumatic connector
- Select the required mode from the main control menu for the workstation chamber.
- Cells can be reintroduced to the workstation from the alternative storage facility through the interlock or SPES (if fitted).

1 Year Service

- Service Kit Contents:
- Large Detox Sachet
- Tristel Fuse Sachet with Trigger Spray Bottle
- Acrylic Anti-static Cleaner
- Sleeves

Service Instructions:

Follow the Deep Cleaning “Preparation” stage for both sides of the workstation.

Unscrew the 2 thumb screws retaining the ceiling panel in the workstation.



Figure 34: Ceiling Panel Thumb Screws

Pull down the ceiling panel. It has a grab catch also holding it up so may take some force.



Figure 35: Ceiling Panel Handle and Grab Catch

Remove the Large Detox Sachet and replace with the new sachet in the service kit.



Figure 36: Large Detox Sachet

Replace the ceiling panel and the thumbscrews.

Remove the used sleeves from the front screen and dispose of them.



Figure 37: Gloveport Sleeves

Follow the Deep Cleaning 'Cleaning' instructions using the appropriate cleaning material in the service kit, followed by the 'Reinstalling workstation components' section

Fit the new sleeves to the workstation using the new O-rings that are in the service kit.

TROUBLESHOOTING

The Workstation will not switch on

- Check the workstation is plugged in
- Check the Mains socket is switched on
- Check the Circuit Breaker has not tripped
- Check the Workstation fuses have not blown
- Check the plug fuses have not blown

If all the above fail to switch the workstation on contact your local distributor.

The Circuit Breaker Trips

- Remove any plugs from the internal sockets
- Reset the Circuit Breaker
 - If the power does not come on unplug the workstation and check the mains fuses
 - If the circuit breaker trips again contact your local distributor
 - If the power comes back on plug in any internal equipment again and check that this does not trip the breaker. If it does then contact the appropriate representative for that equipment.

Low Gas Pressure

The main causes for the workstation to identify low input gas pressures:

- The gas input pressure is set to low
 - Check the gas supply bottle pressure is set to the recommended levels defined in the Gas Supply Requirements section
- The gas bottle has run out
 - Check the gas supply bottle to make sure that it is not empty
- A gas connection between the bottle and the workstation has come undone
 - Inspect the gas supply line from the workstation to the bottle to check there it has not be disconnected

If the gas pressure alarm is activated during the interlock purge, there may be an issue with input pressure drop during the purge cycle. This can be caused by:

- The gas bottle running very low so it does not have the back pressure to maintain the required flow rate
 - Change the gas bottle and re-run the purge
- Restrictions in the supply of gas at pressure to the workstation
 - Review any restrictions and / or components between the gas supply and the workstation

If all the above fail to clear the alarm then contact your local distributor or Ruskinn.

Excessive Gas Usage

If you have a warning on the touchscreen for excessive gas usage as shown in Screen 23 we recommend you carry out the following to try to rectify the issue:

- Set the workstation to the main menu, Screen 3
- Remove the glove port caps and wipe around the rim of the caps and the internal seal with an appropriate cleaning agent
- Check that the glove port tube connector is fitted into the floor of the workstation at the front right
- Ensure that the inner interlock door is firmly shut and that the door clamps are holding it in place
- If the workstation is fitted with the ultrasonic Humidity option check that the main water tank is fitted and that the 2 tubes are fitted correctly
- Check that the gas bottle pressures are set appropriately as detailed in the section

Additionally you can also remove the front screen to wipe around the internal edge of the screen and the seal of the workstation.

If the problem persists after the above have been carried out then please contact your distributor to assist in identifying the issue or to arrange a service engineer visit.

Internal Equipment not powering up

If 3rd party equipment being used in the workstation are not powering up then check the following:

- Check the power / current rating of the equipment. There is a 2A limit for internal equipment and if the equipment exceeds this then it will likely blow an internal fuse. If this is the case then you will need to contact your local distributor for repair
- Check that the internal sockets are switched on through either Screen 14 or Screen 19
- Check that both ends of the mains cable are fully inserted into their sockets

If the above do not work then try to power the equipment from a wall socket to check that it is working properly. If it does work correctly outside of the workstation then contact your local distributor or Ruskinn for further assistance.

The Workstation is only partially operational

If some features of the workstation are not working correctly then please contact your local distributor to arrange a service engineer visit.

WARRANTY INFORMATION

Ruskinn Technology Limited warrants for the applicable time period that the InvivO₂ will substantially perform in accordance with the user documentation. The terms of this Agreement do not affect or prejudice the statutory rights of a consumer acquiring the Ruskinn Technology Limited InvivO₂ otherwise than in the normal course of a business.

THIS WARRANTY DOES NOT APPLY IN THE FOLLOWING CIRCUMSTANCES:

(A) IF THE Ruskinn Technology Limited InvivO₂ HAS BEEN REPAIRED BY PERSONS NOT AUTHORIZED BY Ruskinn Technology Limited; OR

(B) THE Ruskinn Technology Limited InvivO₂ AND ASSOCIATED ACCESSORIES/PERIPHERALS HAVE BEEN ALTERED, MODIFIED, OR MISUSED; OR

(C) THE Ruskinn Technology Limited InvivO₂ IS USED WITH NON- Ruskinn Technology Limited COMPONENTS; OR

(D) THE Ruskinn Technology Limited InvivO₂ OR A COMPONENT IS USED FOR OTHER USES (FOR EXAMPLE USE WITH OTHER CIRCUIT BOARDS OR SOFTWARE) OR

(E) THE Ruskinn Technology Limited InvivO₂ HAS NOT BEEN MAINTAINED OR USED IN ACCORDANCE WITH THE INSTALLATION AND USER GUIDE. UNLESS PROHIBITED BY LAW, THIS WARRANTY IS MADE IN LIEU OF ALL OTHER WARRANTIES, EXPRESS OR IMPLIED, INCLUDING BUT NOT LIMITED TO THE IMPLIED WARRANTY OF FITNESS FOR A PARTICULAR PURPOSE, THE IMPLIED WARRANTY OF MERCHANTABILITY, OR ANY IMPLIED WARRANTY ARISING OUT OF A COURSE OF DEALING OR OF PERFORMANCE, CUSTOM OR USAGE OF TRADE. Ruskinn Technology Limited DOES NOT WARRANT THAT THE Ruskinn Technology Limited InvivO₂ WILL FUNCTION ERROR FREE.

If within the Warranty Period, the Ruskinn Technology Limited InvivO₂ does not conform to the express warranty set forth above, Ruskinn Technology Limited's sole obligation and Users sole remedy shall be, at Ruskinn Technology Limited's option: 1. to repair or replace the non-conforming component; or, 2. refund the purchase price.

LIMITATION OF LIABILITY.

UNLESS PROHIBITED BY LAW, Ruskinn Technology Limited WILL NOT BE LIABLE TO USER OR OTHERS FOR ANY OTHER DIRECT, INDIRECT, CONSEQUENTIAL, INCIDENTAL OR SPECIAL DAMAGES INCLUDING,

FOR EXAMPLE, LOST PROFITS, BUSINESS, INVESTMENTS, OR OPPORTUNITIES EVEN IF Ruskinn Technology Limited HAS BEEN ADVISED OF THE POSSIBILITY OF SUCH DAMAGES.

The parties agree that Ruskinn Technology Limited total cumulative liability to User for direct damages for all causes under this Agreement shall not exceed £5,000,000 (FIVE MILLION UK STERLING POUNDS), or the price paid for the Ruskinn Technology Limited InvivO₂ whichever is higher. Some states or countries may have laws which require liability rights different from those stated above. In such states or countries, the minimum required liability terms shall apply.

DISPOSAL INFORMATION

InvivO₂ contains hazardous components and must not be disposed of at a household waste site. Instead it should be taken to the appropriate collection point for the recycling of electrical and electronic equipment. Alternatively, please contact your local distributor for disposal instructions.

InvivO₂ contains recyclable parts. Please contact your local distributor for more advice

CONTACT DETAILS

Ruskinn Technology Limited

Address:

8 & 9 York Park,
Bridgend Industrial Estate
Bridgend CF31 3TB
United Kingdom

Phone: +44 (0)1656 645988

Fax: +44 (0)1656 667966

Email:

Sales: sales@ruskinn.com

Technical support: techsupport@ruskinn.com

General enquiries: ruskinnooffice@ruskinn.com

Website: www.bakerruskinn.com

YouTube channel <http://www.youtube.com/ruskinntechnology>

Ruskinn Technology Limited is a registered company in United Kingdom, company number 05692599

Ruskinn Technology Limited is VAT registered in United Kingdom, VAT number 870194126

Ruskinn Technology Limited is a wholly owned subsidiary of The Baker Company