

Panasonic[®]

Operating Instructions

Cooled Incubator

MIR-554

MIR-554 Series

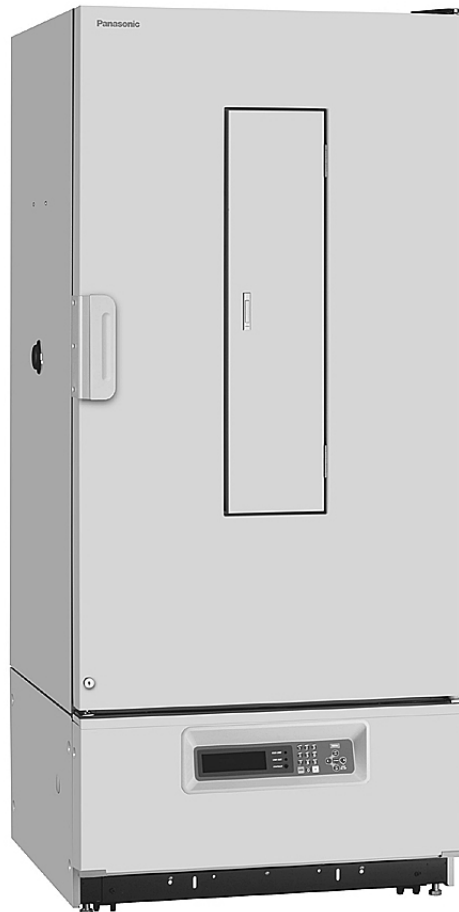

Please read these instructions carefully before using this product, and save this manual for future use.
See page 59 for all Model Nos.

CONTENTS

INTRODUCTION	P. 3
PRECAUTIONS FOR SAFE OPERATION	P. 4
ENVIRONMENTAL CONDITIONS	P. 8
INCUBATOR COMPONENTS	P. 9
Control panel	P. 11
Switch box	P. 12
INSTALLATION SITE	P. 13
INSTALLATION	P. 14
TOP SCREEN	P. 15
FUNCTIONS THROUGH CONTROL PANEL	P. 16
STANDBY OPERATION (MENU/Std-by)	P. 16
SETTING OF KEY LOCK (MENU/Std-by)	P. 17
Setting of key lock (Key Lock)	P. 17
Setting of key unlock (Key Unlock)	P. 17
PROCEDURES OF SETTING VALUE	
Setting of chamber temperature	P. 18
Setting of key lock	P. 19
HIGH LIMIT/LOW LIMIT ALARM (MENU/Std-by)	P. 20
PROGRAMMING (MENU/Edit)	P. 21
EDIT OF SAVED PROGRAM (MENU/Edit)	P. 27
START OF PROGRAM (MENU/Run)	P. 28
JOIN FUNCTION	P. 30
SKIP OF STEP (MENU/Skip)	P. 31
STOP OF PROGRAM (MENU/Stop)	P. 32
AUTOMATIC DEFROST (MENU/Tools/Date Time)	P. 33
MANUAL DEFROST (MENU/M.def)	P. 34
VARIOUS SETTING (MENU/Tools)	P. 35
Display of log (Tools/Log)	P. 35
Setting of date, time, log (Tools/Date Time)	P. 38
Alarm setting (Tools/Alarm, Opt., Low Humi. Setting)	P. 39
Key lock password setting (Tools/Key Lock PW Setting)	P. 40
Default setting (Tools/Default Setting)	P. 41
Delete of program (Tools/Delete User Data)	P. 42
ADJUSTMENT OF SHELVES	P. 44
ALARMS AND SAFETY FUNCTIONS	P. 45
MAINTENANCE	
Cleaning	P. 48
Cleaning of evaporating tray	P. 49
Replacement of lamp	P. 49
Replacement of glow starter	P. 50
Replacement of glow starters (Optional light add on kit MIR-L15)	P. 50

CONTENTS

TROUBLESHOOTING	P. 51
DISPOSAL OF UNIT	P. 51
LOW HUMIDITY MODE	P. 56
PERFORMANCE DATA	P. 57
SPECIFICATIONS	P. 58
PERFORMANCE	P. 59
SAFETY CHECK SHEET	P. 60

INTRODUCTION

- Read this operating instruction carefully before using the Product and follow the instructions for safety operation.
- Our company disavows any responsibility for safety if the Product is used for other than the intended use or used with any procedures other than those given in this operating instruction.
- Keep this operating instruction in a suitable place so that it can be referred to as necessary.
- The contents of this operating instruction are subject to change without notice for improvement of performance or functions.
- Contact our sales representative or agent if any page of the operating instruction is lost or the page order is incorrect.
- Contact our sales representative or agent if any point in this operating instruction is unclear or if there are any inaccuracies.
- No part of this operating instruction may be reproduced in any form without the expressed written permission of our company.

CAUTION

Our company guarantees the product under certain warranty conditions. Our company in no way shall be responsible for any loss of content or damage of content.

Microsoft, Windows, Windows 7, Windows Vista, Windows XP and Windows 2000 are registered trademarks in the United States of Microsoft Corporation and various other countries.

PRECAUTIONS FOR SAFE OPERATION

It is imperative that the user complies with this operating instruction as it contains important safety advice.

Items and procedures are described so that you can use this unit correctly and safely. If the precautions advised are followed, this will prevent possible injury to the user and any other person.

Precautions are illustrated in the following way:



WARNING

Failure to observe WARNING signs could result in a hazard to personnel possibly resulting in serious injury or death.

CAUTION

Failure to observe CAUTION signs could result in injury to personnel and damage to the unit and associated property.

Symbol shows;

-  this symbol means caution.
-  this symbol means an action is prohibited.
-  this symbol means an instruction must be followed.

Be sure to keep this operating instruction in a place accessible to users of this unit.

















< Label on the unit >

This mark is labeled on the cover in which the electrical components of high voltage are enclosed to prevent the electric shock.

The cover should be removed by a qualified engineer or a service personnel only.













PRECAUTIONS FOR SAFE OPERATION

WARNING

-  **Do not use the unit outdoors.** Current leakage or electric shock may result if the unit is exposed to rain water.
-  **Only qualified engineers or service personnel should install the unit.** The installation by unqualified personnel may cause electric shock or fire.
-  **Install the unit on a sturdy floor and take an adequate precaution to prevent the unit from turning over.** If the floor is not strong enough or the installation site is not adequate, this may result in injury from the unit falling or tipping over.
-  **Never install the unit in a humid place or a place where it is likely to be splashed by water.** Deterioration of the insulation may result which could cause current leakage or electric shock.
-  **Never install the unit in a flammable or volatile location.** This may cause explosion or fire.
-  **Never install the unit where acid or corrosive gases are present** as current leakage or electric shock may result due to corrosion.
-  **Always ground (earth) the unit to prevent electric shock.** If the power supply outlet is not grounded, it will be necessary to install a ground by qualified engineers.
-  **Never ground the unit through a gas pipe, water main, telephone line or lightning rod.** Such grounding may cause electric shock in the case of an incomplete circuit.
-  **Connect the unit to a power source as indicated on the rating label attached to the unit.** Use of any other voltage or frequency other than that on the rating label may cause fire or electric shock.
-  **Never store volatile or flammable substances** in this unit if the container cannot be sealed. These may cause explosion or fire.
-  **Do not insert metal objects such as a pin or a wire into any vent, gap or any outlet on the unit.** This may cause electric shock or injury by accidental contact with moving parts.
-  **Use this unit in safe area when treating the poison, harmful or radiate articles.** Improper use may cause bad effect on your health or environment.
-  **Turn off the power switch (if provided) and disconnect the power supply to the unit prior to any repair or maintenance** of the unit in order to prevent electric shock or injury.
-  **Do not touch any electrical parts (such as power supply plug) or operate switches with a wet hand.** This may cause electric shock.







PRECAUTIONS FOR SAFE OPERATION

WARNING

-  **Ensure you do not inhale or consume medication or aerosols** from around the unit at the time of maintenance. These may be harmful to your health.
-  **Never splash water directly onto the unit** as this may cause electric shock or short circuit.
-  **Never put containers with liquid on the unit** as this may cause electric shock or short circuit when the liquid is spilled.
-  **Never bind, process, or step on the power supply cord, or never damage or break the power supply plug.** A broken supply cord or plug may cause fire or electric shock.
-  **Do not use the supply cord if its plug is loose.** Such supply cord may cause fire or electric shock.
-  **Never disassemble, repair, or modify the unit yourself.** Any such work carried out by an unauthorized person may result in fire, or electric shock or injury due to a malfunction.
-  **Disconnect the power supply plug if there is something wrong with the unit.** Continued abnormal operation may cause electric shock or fire.
-  **When removing the plug from the power supply outlet, grip the power supply plug,** not the cord. Pulling the cord may result in electric shock or fire by short circuit.
-  **Disconnect the power supply plug** before moving the unit. Take care not to damage the power cord. A damaged cord may cause electric shock or fire.
-  **Disconnect the power plug when the unit is not used for long periods.** Keeping the connection may cause electric shock, current leakage, or fire due to the deterioration of insulation.
-  If the unit is to be stored unused in an unsupervised area for an extended period, **ensure that children do not have access and that doors cannot be closed completely.**
-  **The disposal of the unit should be accomplished by appropriate personnel.** Remove doors to prevent accidents such as suffocation.
-  **Do not put the packing plastic bag within reach of children** as suffocation may result.

PRECAUTIONS FOR SAFE OPERATION

CAUTION

-  This unit must be plugged into a dedicated circuit protected by branch circuit breaker.
-  Use a dedicated power source as indicated on the rating label attached to the unit. A multiple-tap may cause fire resulting from abnormal heating.
-  **Never store corrosive substances such as acid or alkali** in this unit if the container cannot be sealed. These may cause corrosion of inner components or electric parts.
-  **Consult our sales representative or agent** when you use a material resulting in the corrosive gas such as in the case of insect breeding.
-  **Check the setting when starting up of operation after power failure or turning off of power switch.** The stored items may be damaged due to the change of setting.
-  **Be careful not to tip over the unit** during movement to prevent damage or injury.
-  **Prepare a safety check sheet** when you request any repair or maintenance for the safety of service personnel.

ENVIRONMENTAL CONDITIONS

This equipment is designed to be safe at least under the following conditions (based on the IEC 61010-1):

- Indoor use;
- Altitude up to 2000 m;
- Ambient temperature 5 °C to 40 °C
- Maximum relative humidity 80 % for temperature up to 31 °C decreasing linearly to 50 % relative humidity at 40 °C;
- Mains supply voltage fluctuations not to exceed ± 10 % of the nominal voltage;
- Other supply voltage fluctuations as stated by the manufacturer;
- Transient overvoltages according to Installation Categories (Overvoltage Categories) II; For mains supply the minimum and normal category is II;
- Pollution degree 2 in accordance with IEC 60664.

INCUBATOR COMPONENTS

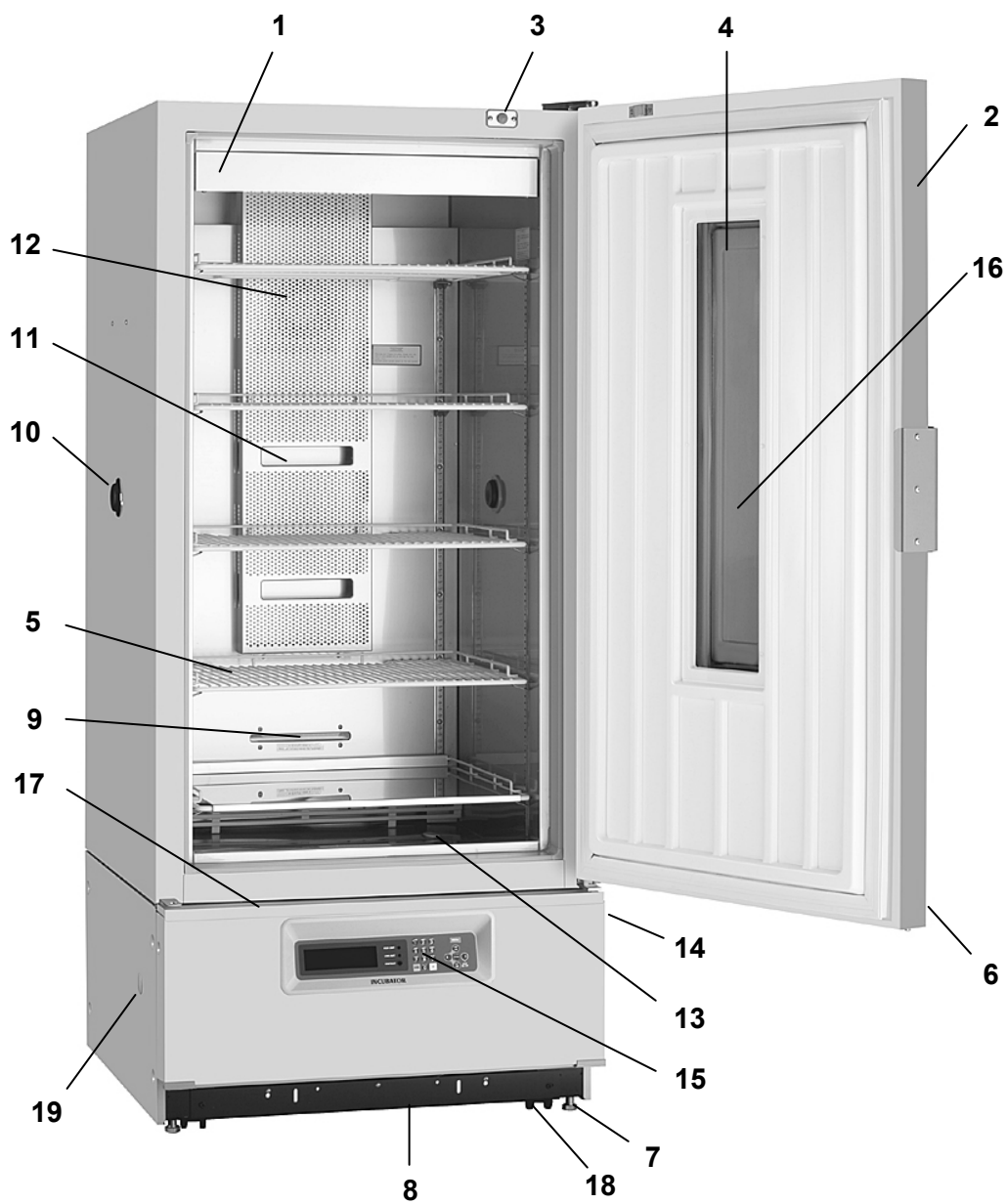

INCUBATOR COMPONENTS

1. Shade: To protect the fluorescent lamp.

2. Door: The door can be opened to 130 degrees approx. The door is sealed securely to the cabinet by the magnetic gasket when it is closed.

Condensation may occur at the inner side of the door when a lot of damp material stored.

3. Door switch: To prevent the air from escaping by stopping the air circulating fan when the door is opened.

4. Glass window: 3-layer heat-absorbing glass to shut out the heat.

5. Shelf: The location (height) is adjustable according to the item size to be stored.

Do not change the position of the lowest shelf or do not remove the stainless panel on the lowest shelf to keep original airflow inside the chamber.

6. Keyhole: Insert the key and turn 180 degrees to the left, and the door is locked.

7. Leveling foot: Use these bolts to adjust the height and level the unit for installation.

8. Evaporating tray: The drained water resulting from the defrosting is accumulated and evaporated automatically in this tray. (Page 49)

9. Frost check opening: Check the frost on the condenser through this opening.

10. Access port: This port allows cables to be passed into the cabinet.

Note: Be sure to set the rubber stopping to the access port (placed at the left and right side) as it was when passing cables for measurement and power cords through it.

Be sure to replace the cap after take out cable or, the inside temperature cannot complete down, and frost may accumulate outside the port surroundings.

11. Air blowing duct: The heat-exchanged air is blown out from this duct.

12. Air circulating fan: Fan is installed inside the duct. Do not insert anything into the duct.

13. Drain port: Use this port when the chamber is washed with water. Always cover the port with cap when no use.

14. Switch box: Power switch, remote alarm terminals, and glow starter are placed.

15. Control panel: Temperature control, alarm setting, program setting are available through the control panel. The temperature indicator is attached on the control panel.

16. Glass protective plate: This is prevented from glass cracking.

17. Dew saucer: To hold the dew that adhere to inside of the door.

18. Caster: To facilitate the moving of the cabinet.

19. Port for drain pipe: To take out the drain pipe to avoid the overflow of the evaporating tray in the case of long term humidity operation. (Page 56)

INCUBATOR COMPONENTS

Control panel

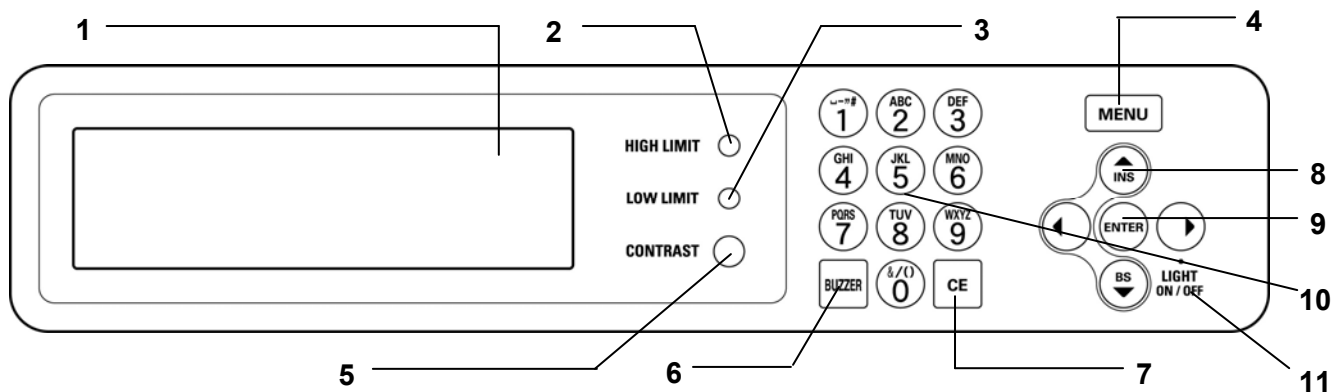

1. LCD panel

2. High limit temperature alarm volume (HIGH LIMIT)

To set the temperature of high limit temperature alarm.

3. Low limit temperature alarm volume (LOW LIMIT)

To set the temperature of low limit temperature alarm.

4. Menu button (MENU)

To open the menu window.

5. LCD contrast adjusting knob (CONTRAST)

To adjust the contrast of LCD.

6. Alarm buzzer stop key (BUZZER)

To silence the alarm buzzer temporarily.

7. Clear key (CE)

To clear the input value during editing of program.

8. Shift key (Upward, downward, rightward, leftward)

To move the cursor on the LCD panel.

9. Enter key (ENTER)

To determine the selection of menu. In program editing, pressing this key causes moving to a next article.

10. Character input key

11. Fluorescent lamp key (LIGHT ON/OFF)

The key for ON/OFF of fluorescent lamp.

The key is used for the cursor movement on various setting.

※The lighting is available only with temperature range between +2 °C and +50 °C when the optional Light add on kit (MIR-L15) is installed.

INCUBATOR COMPONENTS

Switch box

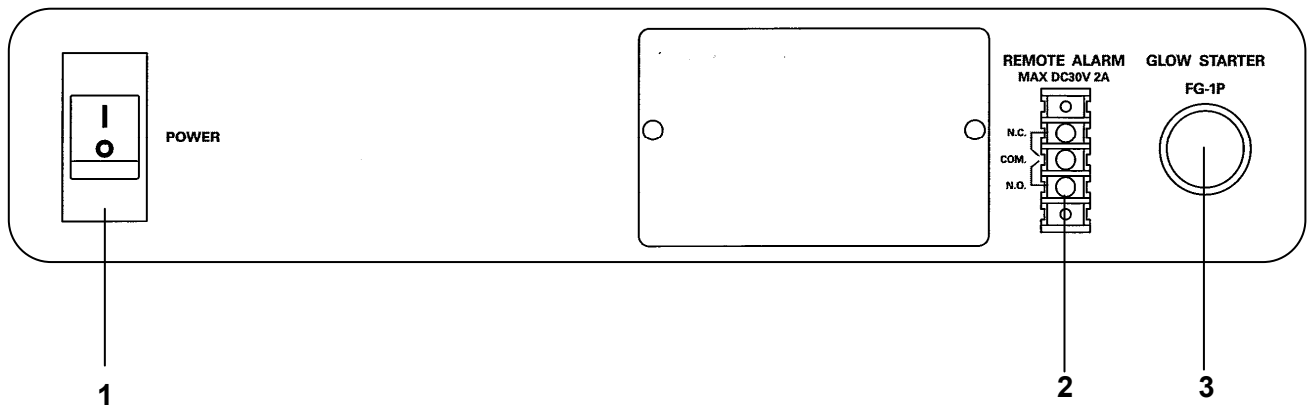

1. Power switch (POWER)

The switch for ON/OFF of all power source.

2. Remote alarm terminals

Alarm signal can be drawn out via the contact output. Permissible contact capacity: DC 30 V, 2 A

a) Contact output: Connect the lead wires to COM and NO terminals.

(Normal condition: open. Abnormal condition: close.)

b) Contact output: Connect the lead wires to COM and NC terminals.

(Normal condition: close. Abnormal condition: open.)

COM and NO terminals are closed at the failure of electricity supply.

3. Glow starter (type: FG-1P)

INSTALLATION SITE

To operate this unit properly and to obtain maximum performance, install the unit in a location with the following conditions:

■ **A location not subjected to direct sunlight**

Do not install the unit under direct sunlight. Installation in a location subjected to direct sunlight cannot obtain the intended performance.

■ **A location with adequate ventilation**

Leave at least 10 cm around the unit for ventilation. Poor ventilation will result in a reduction of the performance and consequently the failure.

■ **A location away from heat generating sources**

Avoid installing the unit near heat-emitting appliances such as a heater or a boiler etc. Heat can decrease the intended performance of the unit.

■ **A location with little temperature change**

Install the unit under stable ambient temperature. The allowable ambient temperature is between +5 °C and +35 °C.

Note: This incubator changes to PID control when the temperature setting is about 10 °C higher than the ambient temperature. Under PID control, the temperature cycle is very small. For other temperature setting, the incubator is operated with ON-OFF control, which temperature cycle is about 3 °C. At the beginning of operation or when the ambient temperature is fairly high, the cabinet side may heat up. However, this does not denote a malfunction. It is due to the hot gas piped around the unit frame to prevent condensation around the cabinet.

■ **A location with a sturdy and level floor**

Always install the unit on a sturdy and level floor. The uneven floor or tilted installation may cause failure or injury. Install the unit in stable condition to avoid the vibration or noise. Unstable condition may cause vibration or noise.

 **WARNING**

Install the unit on a sturdy floor. If the floor is not strong enough or the installation site is not adequate, this may result in injury from the unit falling or tipping over.

Select a level and sturdy floor for installation. This precaution will prevent the unit from tipping. Improper installation may result in water spillage or injury from the unit tipping over.

■ **A location not prone to high humidity**

Install the unit in the ambient of 80 %R.H. or less humidity. Installation under high humidity may cause current leakage or electric shock.

 **WARNING**

Do not use the unit outdoors. Current leakage or electric shock may result if the unit is exposed to rain water.

Never install the unit in a humid place or a place where it is likely to be splashed by water. Deterioration of the insulation may result which could cause current leakage or electric shock.

■ **A location without flammable or corrosive gas**

Never install the unit in a flammable or corrosive location. This may cause explosion or fire or may result in the current leakage or electric shock by the corrosion of the electrical components.

INSTALLATION SITE

CAUTION

Do not install it on the place (near the drain facilities etc.) where the corrosion cause material like the sulfur compound etc. might be generated. The refrigeration unit is deteriorated, and it causes the breakdown of the product due to the corrosion of the copper pipe.

■ A location where nothing falls on

Do not install the product where things might fall on it. The product might be damaged, and it causes a breakdown.

INSTALLATION

1. Remove the door fixture

Loosen 4 screws and remove the door fixture at the top left of the cabinet.

2. Remove the packaging materials and tapes

Remove all transportation packaging materials and tapes. Open the doors and ventilate the unit. If the outside panels are dirty, clean them with a diluted neutral dishwashing detergent. (Undiluted detergent can damage the plastic components. For the dilution, refer to the instruction of the detergent.) After the cleaning with the diluted detergent, always wipe it off with a wet cloth. Then wipe off the panels with a dry cloth.

Note:

Remove the cable tie banding the power supply cord. Prolonged banding may cause the corrosion of the cord coating.

3. Adjust the leveling foot

Extend the leveling feet by rotating them counterclockwise to contact them to the floor. Ensure the unit is level.

4. Ground (earth)

WARNING

Use a power supply outlet with ground (earth) to prevent electric shock. If the power supply outlet is not grounded, it is necessary to install a ground by qualified engineers.

Never ground the unit through a gas pipe, water main, telephone line or lightning rod. Such grounding may cause electric shock in the case of an incomplete circuit.

Note:

The chamber temperature may deviate from the set temperature when the unit is running with the heater or motor energized.

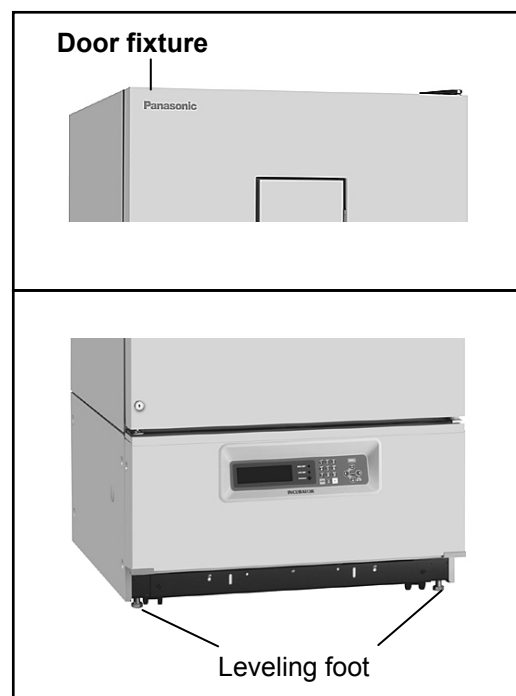

TOP SCREEN

The top screen below is displayed when turning on the power switch. The default temp. is 25.0 °C. The date and time are preset at the factory. Refer to page 38 when more accurate setting is needed.

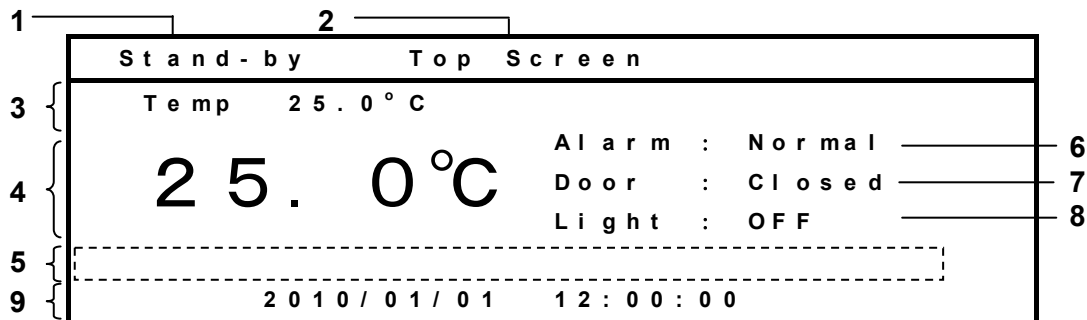

1. Display of running status

The current running status is displayed. At the power-on, "stand-by" is displayed and the system runs continuously under the stand-by running condition (refer to page 16). When turning on power for the first time, the system runs continuously under the initial setting condition.

"Running" is displayed at the time of programmed running. "Defrosting" is displayed with reversed and non-reversed character alternately while removing frost.

"Low Humi." is displayed with reversed and non-reversed character alternately while low humidity mode.

2. Display of program name

A program name under operation is displayed. "Top Screen" is displayed during standby operation.

3. Display of setting

Set value of temperature is displayed.

4. Display of current value

Current value of temperature is displayed.

5. Message display field

A message is displayed when a breakdown occurs.

6. Alarm display (Alarm)

"Alarm" is alternately displayed by reversed/non-reversed character while alarm is operating.

"Warning" is alternately displayed by reversed/non-reversed character at the time of warning.

"Normal" is displayed at a normal condition.

An adding message is displayed in the message display field.

7. Display of door status

"Door" is highlighted when the door is open. "Closed" is displayed when the door is closed.

8. Lighting display (Light)

"ON" is displayed in outline type when the lighting has been turned on. "OFF" is displayed when turned off.

When the lighting is set to be turned on, the system is programmed running, "Program_ON" is displayed in outline type when the lighting has been turned on and "Program_OFF" is displayed in outline type when the lighting has been turned off.

9. Display of date and time

The current date and time is displayed.

FUNCTIONS THROUGH CONTROL PANEL

The following functions are available through control panel:

- **Setting of standby operation:** To set a running condition at the start-up or completion of programmed running. (refer to page 16)
- **Programming and edit:** To set a new program (page 21), or to edit (page 27), or delete (page 42) an user program.
- **Programmed running:** To start (page 28), skip (page 31) or stop (page 32) a programmed running.
- **Setting of defrost:** To set the automatic defrost (page 33) and to start the manual defrost. (page 34)
- **Setting of log cycle and sending to PC:** To set a log cycle of running data and to send a running log to PC. (page 37)
- **Setting of date and time:** To set the date and time shown on the top screen. (page 38)
- **Setting of alarm:** To set temperature alarm (page 39) and a high limit (or low limit) temperature alarm. (page 20)
- **Setting for optional component:** To set when an optional component is installed. (page 39)
- **Setting of low humidity mode:** To set the running for low humidity. (page 39)
- **Default setting:** To set the default for LCD panel and communication (DAQ) speed etc. (page 41)

STANDBY OPERATION (MENU/Std-by)

This product automatically operates with standby operation setting.

1. With the top screen displayed, press the menu button (MENU) to show the menu window. Select "Std-by" and press the enter key (ENTER).

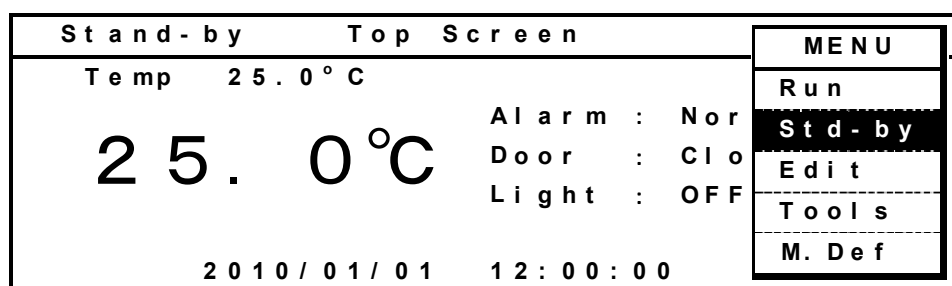

2. Stand-by Setting screen is displayed. Set each parameter.

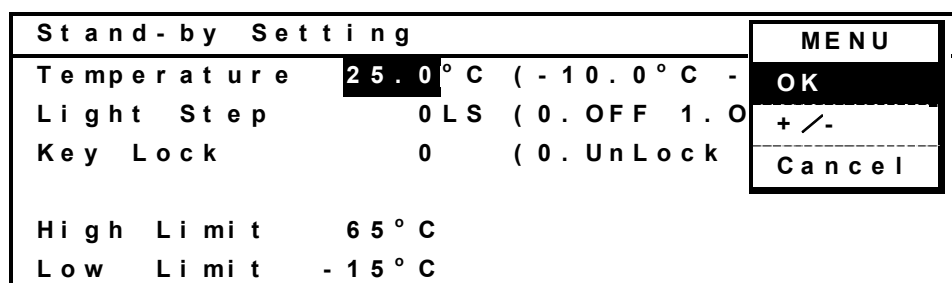

3. Press the menu button (MENU) at the completion of parameter setting. The menu window is shown. Select "OK" and press the enter key (ENTER). The parameter is memorized.

The settable range of each parameter:

- Temperature : -10°C~60°C

※The settable range and screen display is -10°C~+50°C when the optional inner door (MIR-55ID) is installed.

STANDBY OPERATION (MENU/Std-by)

■ Light step: 1 (ON) or 0 (OFF). In the case of selecting 0 (OFF), by pressing rightward shift key, lighting is turned on or off when the top screen is displayed.

(While the program operates, on/off of lighting depends on the program.)

※The lighting is available only with temperature range between +2°C and +50°C when the optional light add on kit (MIR-L15) is installed.

■ Key Lock : When selecting 1 (Lock), it is not possible to change any parameter. To unlock, it is required to input the key lock password.

Refer the next for the details.

SETTING OF KEY LOCK (MENU/Std-by)

Setting of key lock (Key Lock)

1. When setting of key lock, change the value of the key lock line from “0” to “1” in the stand-by setting screen (Stand-by Setting) and press the enter key (ENTER). The buzzer rings for a short while, and then the key is locked.

Stand-by Setting		MENU
Temperature	25.0°C (-10.0°C -	OK
Light Step	0LS (0.OFF 1.O	Cancel
Key Lock	1 (0.UnLock	
High Limit	65°C	
Low Limit	-15°C	

2. The other settings except key lock cannot be changed.

Setting of key unlock (Key Unlock)

1. When setting of key unlock, change the value of the key lock line from “1” to “0” in the stand-by setting screen (Stand-by Setting) and press the enter key (ENTER).

Stand-by Setting	Key Lock
Temperature	25.0°C (-10.0°C - +60.0°C)
Light Step	0LS (0.OFF 1.ON)
Key Lock	0 (0.UnLock 1.Lock)
High Limit	65°C
Low Limit	-15°C

2. Input password of 4 digits to the password field (Password) where the cursor is moved to, and press the enter key (ENTER). When setting of key unlock, the buzzer rings for a short while, and then “Key Lock” disappears in the stand-by setting screen (Stand-by Setting).

Stand-by Setting	Key Lock
Temperature	25.0°C (-10.0°C - +60.0°C)
Light Step	0LS (0.OFF 1.ON)
Key Lock	0 Password ****
High Limit	65°C
Low Limit	-15°C

SETTING OF KEY LOCK (MENU/Std-by)

Caution:

The buzzer rings for a long time when a wrong password is input. Input a correct password.
The password for key unlock must be shared and administered by all users on this product.
The duration is set in "0000" at the factory.
Refer to page 40 for changing the password.

PROCEDURES OF SETTING VALUE

Setting of chamber temperature

Procedures of changing chamber temperature from 25 °C to -10 °C are shown below. As for other values, the same procedure is applied.

Procedures of changing chamber temperature from 25 °C to -10 °C

	Operation	Key	LCD Display			
1		----	Top screen is displayed.			
2	Press the menu button (MENU).	MENU	MENU window is displayed.			
3	Select Std-by in MENU window and press the enter key (ENTER).	ENTER	Stand-by Setting screen is displayed and chamber temperature setting value is changed into white letters.			
4	Change the value from 25.0 to 10.0 pressing the character input key.	<table border="1"><tr><td>1</td><td>0</td><td>0</td></tr></table>	1	0	0	Chamber temperature setting value 10.0 is displayed.
1	0	0				
5	Press the menu button (MENU).	MENU	MENU window is displayed.			
6	Select +/- in MENU window and press the enter key (ENTER).	ENTER	Chamber temperature setting value -10.0 is displayed.			
7	Press the enter key (ENTER).	ENTER	Next item (Light Step) is displayed in white letters.			
8	Press the menu button (MENU).	MENU	MENU window is displayed.			
9	Select OK in MENU window and press the enter key (ENTER).	ENTER	The set value is memorized and top screen is displayed.			

CAUTION

The settable range of chamber temperature is between -10 °C and +60 °C.

• The lighting is available only with temperature range between +2 °C and +50 °C when the optional light add on kit (MIR-L15) is installed. In the case of temperature out of range, the lighting is not usable. The lamp is off with the temperature out of range when the saved program is running.

In this case, temperature fluctuation may exceed ± 1.5 °C or it may take longer time to pull down the chamber temperature.

• The temperature control range is -10 °C ~ +50 °C when the optional inner door (MIR-55ID) is installed. The temperature is limited to 50 °C when the saved program includes temperature setting over 50 °C. In this case, the temperature setting over 50 °C is indicated by blinking.

PROCEDURES OF SETTING VALUE

Setting of key lock

Procedures of changing Key Lock setting are shown below.

Procedures of Key Lock (Changing Key Lock setting from 0(Unlock) to 1(Lock)).

	Operation	Key	LCD Display
1		----	Top screen is displayed.
2	Press the menu button (MENU).	MENU	MENU window is displayed.
3	Select Std-by in MENU window and press the enter key (ENTER).	ENTER	Stand-by Setting screen is displayed and chamber temperature setting value is changed into white letters.
4	Select Key Lock item pressing Shift keys.	▼	Set value of (Key Lock) is displayed in white letters.
5	Change the value from 0 to 1 pressing the character input key.	<input type="text" value="1"/>	Set value "1" is displayed.
6	Press the enter key (ENTER).	ENTER	The value of top item (Temperature) is displayed in white letters. "Key Lock" is displayed in first line.
7	Press the menu button (MENU).	MENU	MENU window is displayed.
8	Select OK in MENU window and press the enter key (ENTER).	ENTER	The set value is memorized and top screen is displayed.

Procedures of Key Unlock (Changing Key Lock setting from 1(Lock) to 0(Unlock)).

	Operation	Key	LCD Display
1		----	Top screen is displayed.
2	Press the menu button (MENU).	MENU	MENU window is displayed.
3	Select Std-by in MENU window and press the enter key (ENTER).	ENTER	Stand-by Setting screen is displayed and chamber temperature setting value is changed into white letters.
4	Select Key Lock item pressing Shift keys.	▼	Set value of (Key Lock) is displayed in white letters.
5	Change the value from 1 to 0 pressing the character input key.	<input type="text" value="0"/>	Set value "0" is displayed.
6	Press the enter key (ENTER).	ENTER	Item of (Password) is displayed.
7	Set the password pressing the character input key.	<input type="text" value="0"/> <input type="text" value="0"/> <input type="text" value="0"/> <input type="text" value="0"/>	The password * * * * is displayed.
8	Press the enter key (ENTER).	ENTER	The value of top item (Temperature) is displayed in white letters. "Key Lock" in first line is disappeared.
9	Press the menu button (MENU).	MENU	MENU window is displayed.
10	Select OK in MENU window and press the enter key (ENTER).	ENTER	The set value is memorized and top screen is displayed.

Note: Consult our sales representative or agent if you put off the password.

HIGH LIMIT/LOW LIMIT ALARM (MENU/Std-by)

A high limit temperature alarm and low limit temperature alarm are provided with this product. The alarm temperature can be changed as follows:

1. With the top screen displayed, press the menu button (MENU) to show the menu window. Select "Std-by", and press the enter key (ENTER).

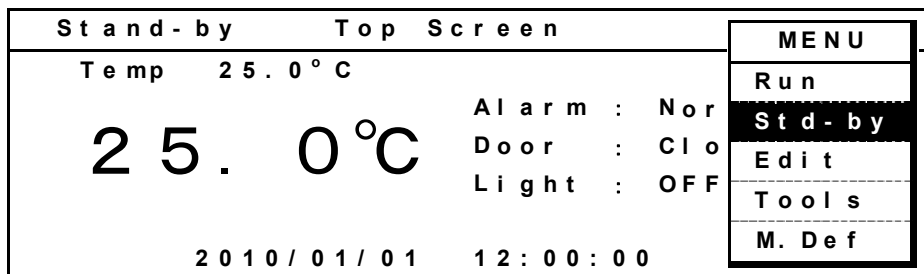

2. Stand-by Setting screen is displayed.

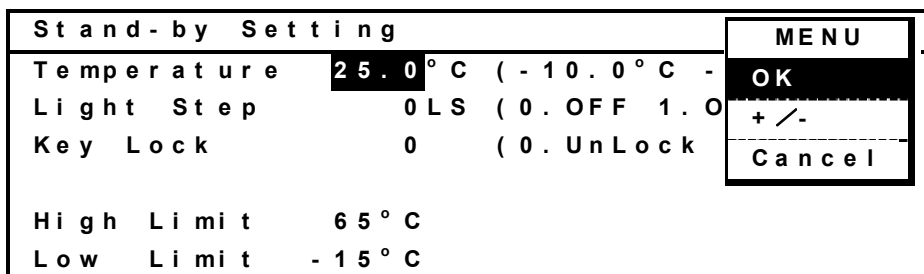

3. Set the desired high limit temperature alarm by turning the high limit temperature alarm volume (HIGH LIMIT) at the center of the control panel by using a small screw driver. The settable alarm temperature is between 15.0 °C and 65.0 °C.

Note:

Set the high limit temperature alarm (High Limit) 5 °C or higher than the maximum temperature in a program or stand-by operation.

4. Set the desired low limit temperature alarm by turning the low limit temperature alarm volume (LOW LIMIT) at the center of the control panel by using a small screw driver. The settable alarm temperature is between -15.0 °C and 20.0 °C.

Note:

Set the low limit temperature alarm (Low Limit) 5 °C or lower than the minimum temperature in a program or stand-by operation.

5. Press the menu button (MENU) at the completion of setting. The menu window is shown. Select "OK" and press the enter key (ENTER). The alarm temperature is memorized.

Refer to alarms and safety functions of page 45 for details.

Note:

High limit temperature alarm (High Limit) and low limit temperature alarm (Low Limit) are effective during a programmed running as well.

At any time when Stand-by Setting screen is not displayed, turning the high and low limit temperature alarm volume (HIGH LIMIT or LOW LIMIT) causes change of the setting value.

To avoid unexpected alarm depending on the ambient temperature or current running status, set High Limit or Low Limit temperature after actual temperature of chamber reaches to the set temperature of operation.

PROGRAMMING (MENU/Edit)

This product has two modes, which are clock mode and timer mode. The clock mode is used to set a change time to the next step in a day time (24 hours). The timer mode is used to set a time for each step directly and the remained time is displayed.

The selection of either mode is available on the running mode selection screen at the starting of the program.

Example 1:

Following shows the procedure to create a new program "Oze" of which cycle is 31 with clock mode.

The details of "Oze" is as follows:

Start time (H)	6:00	9:00	11:00	13:00	15:00	17:00	19:00	21:00	22:00	23:00	6:00
Temp (°C)		12	15	20	25	20	18	15	15	12	10
Lighting		0	1	0	1	0	1	0	1	0	1

1. With the top screen displayed, press the menu button (MENU) to show the menu window.

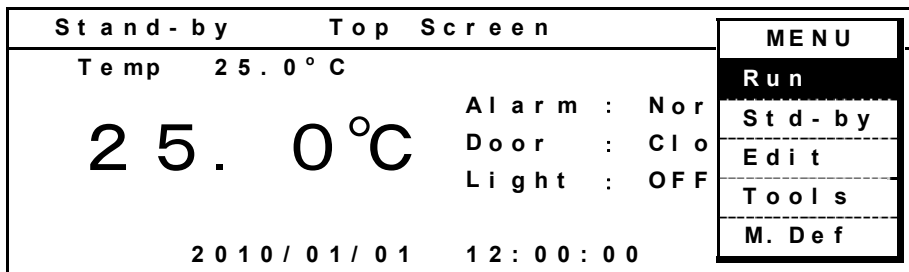

2. Select "Edit", and push the enter key (ENTER).

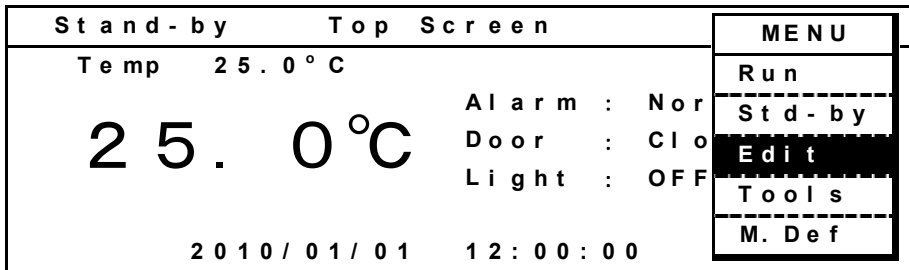

3. The Program Name Stored screen is opened. Press the menu button (MENU) and select "New", and press the enter key (ENTER). The program names are displayed when some programs have already been saved.

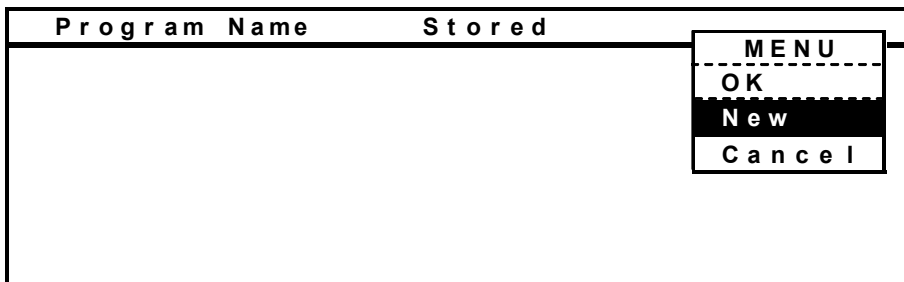

PROGRAMMING (MENU/Edit)

4. A model program is displayed.

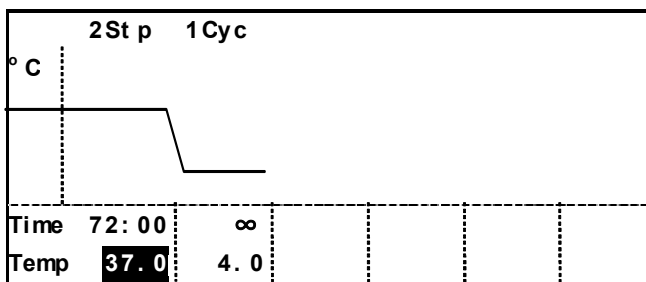

The step number (Stp :step) and cycle number (Cyc :repeat number) can be changed on the top left corner (2 Stp 1 Cyc) of the screen. Highlight the numerical value by shift key, and input 10 Stp 31 Cyc by character input key. The step number and cycle number are changed. The screen is scrolled to the next page by using the rightward shift key.

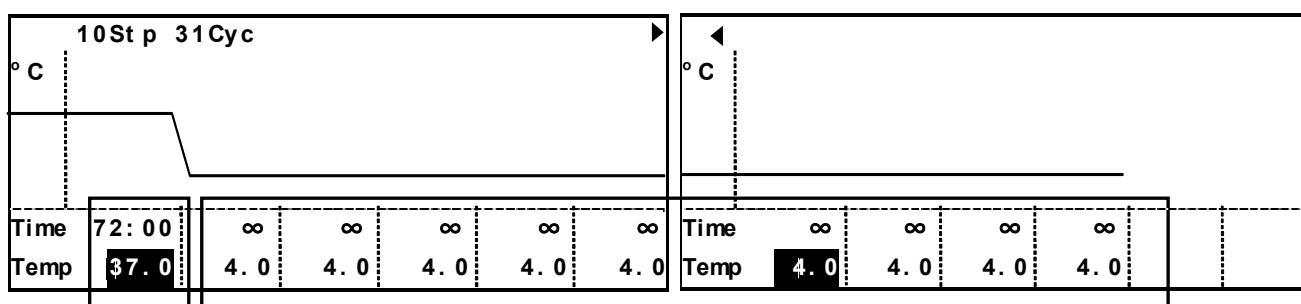

MENU

Save
+ / -
Cancel

MENU

Save
Insert
Delete
+ / -
Cancel

The step number (Spt) can be changed by “Insert” or “Delete” on the menu window. Press the menu button (MENU), to open the menu window. The menu window for a first section has no “Insert” or “Delete”. Therefore, neither insert nor delete is effective for the first section. The maximum step number is 12. The cycle number is 1 when the step number is 1. The settable cycle number is up to 98. The cycle number 99 means limitless repeat.

PROGRAMMING (MENU/Edit)

5. Highlight the numerical value of each time section (Time) by shift key, and input as below by character input key.

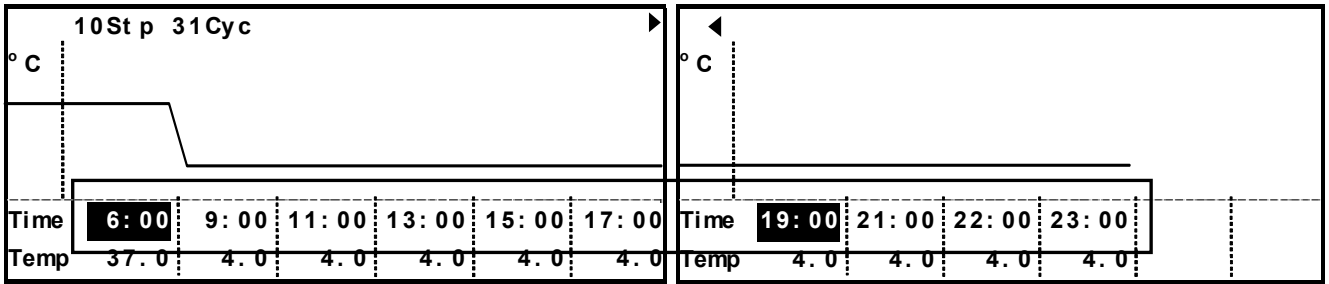

⚠ CAUTION

The time setting value depends on each mode, clock mode and timer mode. In the case of clock mode, the setting range is between 00:00 and 23:59. If the setting is larger than 24:00, the step of immediately before is repeated limitlessly. Set the step with timer order. In the case of timer mode, setting range is between 00:01 and 99:59. The setting of "99:99" causes limitless repeat.

6. Shift a cursor downward by the downward shift key. Set the temperature as follows. The setting range is between -10.0 °C and +60.0 °C.

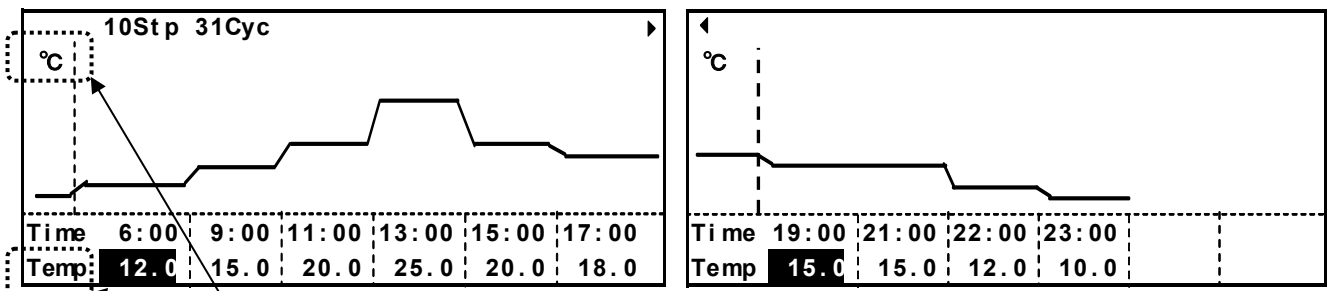

During temperature setting, "°C" is displayed at upper left.

MENU
Save
+ / -
Cancel

When adding the "-" to the set value of temperature or erasing the "-" from the set value of temperature, press the menu button (MENU) to show the menu window. Select +/- and press the enter key (ENTER).

⚠ CAUTION

The settable range of chamber temperature is between -10 °C and +60 °C.

- The lighting is available only with temperature range between +2 °C and +50 °C when the optional light add on kit (MIR-L15) is installed. In the case of temperature out of range, the lighting is not usable. The lamp is off with the temperature out of range when the saved program is running.

In this case, temperature fluctuation may exceed ± 1.5 °C or it may take longer time to pull down the chamber temperature.

- The temperature control range is -10 °C ~ +50 °C when the optional inner door (MIR-55ID) is installed.

The temperature is limited to 50 °C when the saved program includes temperature setting over 50 °C. In this case, the temperature setting over 50 °C is indicated by blinking.

⚠ CAUTION

The unit continues to run with a step just before the step having time setting of over 24:00 when a program is run in clock mode.

PROGRAMMING (MENU/Edit)

7. Shifting a cursor downward by downward shift key moves to the next edit "Light" (light step).

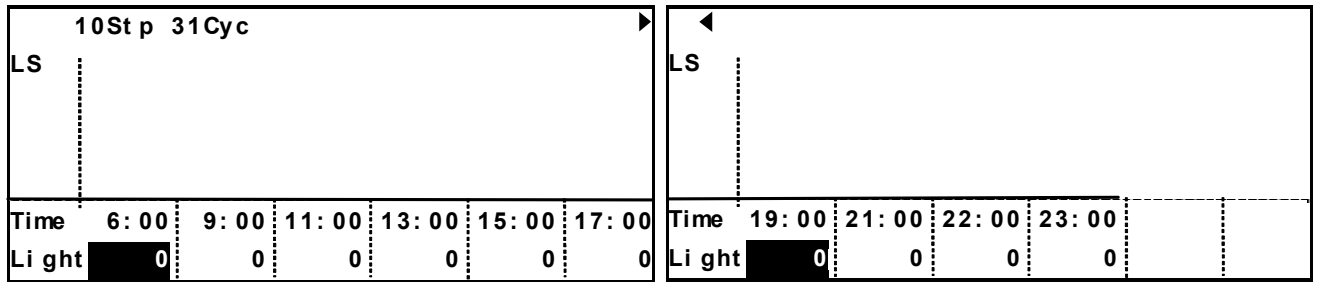

Set a light step as below. To set 0(OFF) or 1(ON).

• Light step can set only the temperature range between +2°C and +50 °C to 1(ON), when the optional light add on kit (MIR-L15) is installed.

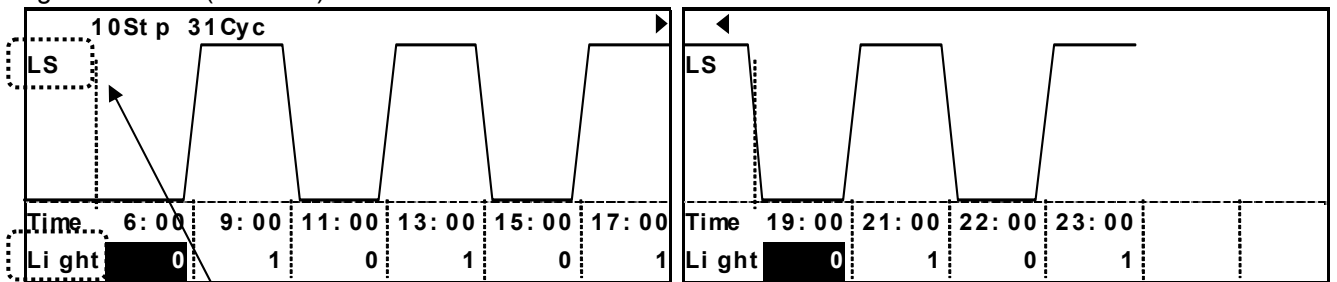

When setting Light step, "LS" displayed at the upper left and "Light" at the lower left on the top screen.

8. Shifting a cursor downward by downward shift key moves to the next edit "Temp" (Temperature).

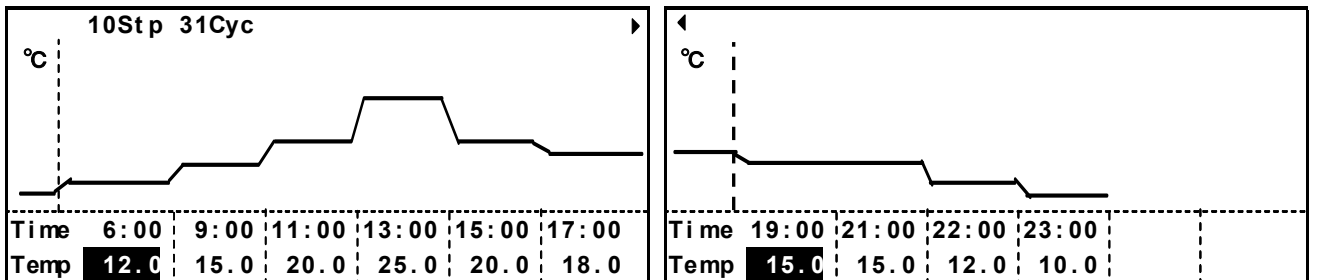

9. At the completion of all input, press the menu button (MENU) to show the menu window. Select "Save", and press the enter key (ENTER). Save Program screen is opened.

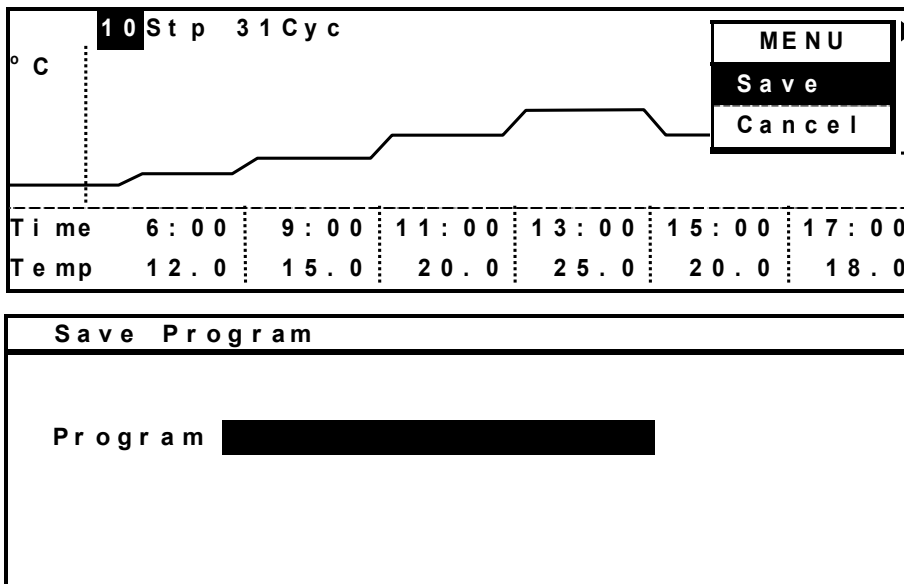

PROGRAMMING (MENU/Edit)

10. Input a program name (Oze), and press the menu button (MENU) to show the menu window. Select "Save As", and press the enter key (ENTER). The program is entered. The maximum numbers of character for program name is 16. Refer to edit function of characters described below. Up to 10 programs are created and saved.

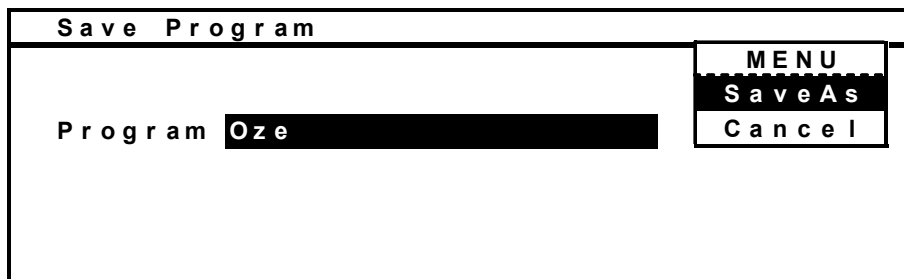

Edit function of characters

Shift key

- **Upward shift key** : Space insertion
- **Downward shift key** : backspace
- **Leftward shift key** : Move a cursor left
- **Rightward shift key** : Move a cursor right

Character input key

1 key : space,-,"#, @,1

2 key : A,B,C,a,b,c,2

3 key : D,E,F,d,e,f,3

4 key : G,H,I,g,h,i,4

5 key : J,K,L,j,k,l,5

6 key : M,N,O,m,n,o,6

7 key : P,Q,R,S,p,q,r,s,7

8 key : T,U,V,t,u,v,8

9 key : W,X,Y,Z,w,x,y,z,9

0 key : &,/, (,),.,0

11. Return to the top screen after saving program.

PROGRAMMING (MENU/Edit)

Example 2:

To create the following program with timer mode and name "NIKKO". The cycle is 99, that is limitless repeat.

Step Time	48	36
Temperature (°C)	20	30
Light Step	0	1

1. Display a model program as shown on page 22.

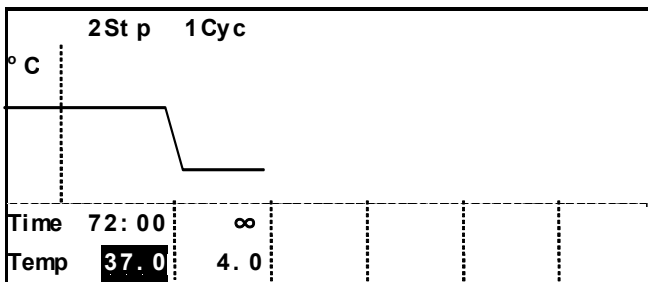

Change the step number and cycle number to 2 Stp and 99 Cyc by character input key. Only one page is displayed and 99 is changed into ∞. Display of ∞ changes 99 when lapped by a cursor.

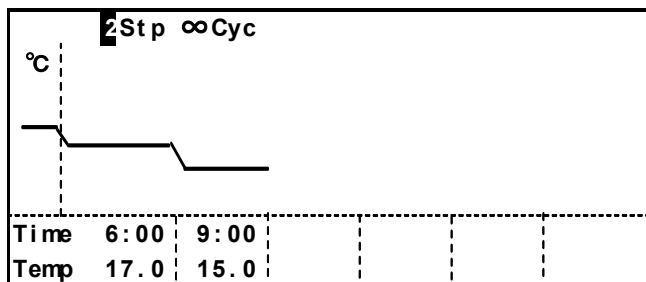
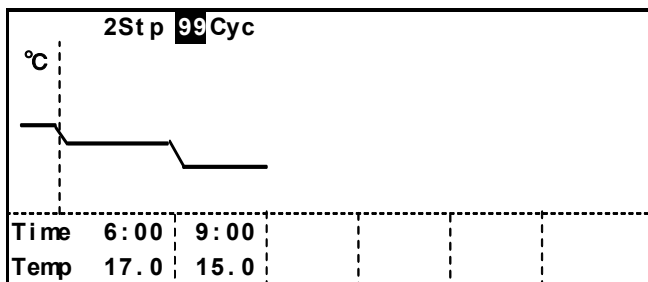

2. Set a time, temperature and light step as same as Example.1.

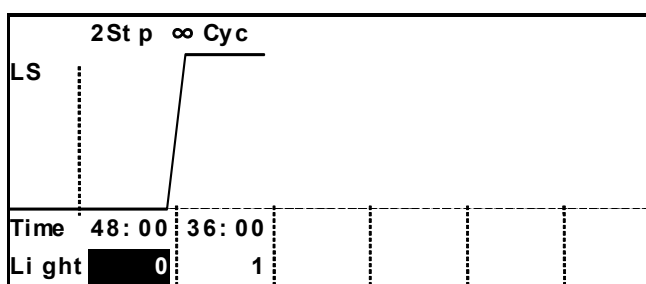
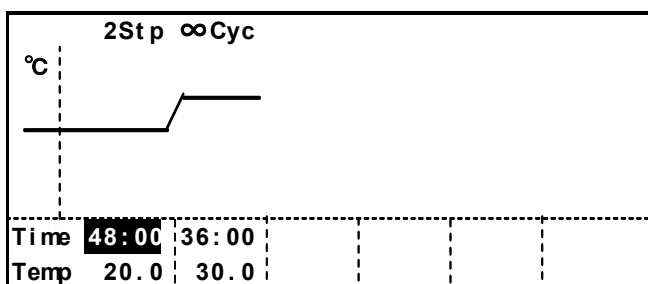

3. Input a program name (NIKKO), pres the menu button (MENU) to show the menu window. Select "Save As", and press the enter key (ENTER) to save the program as same as Example.1.

EDIT OF SAVED PROGRAM (MENU/Edit)

1. With the top screen displayed, press the menu button (MENU) to show the menu window. Select "Edit", and press the enter key (ENTER).

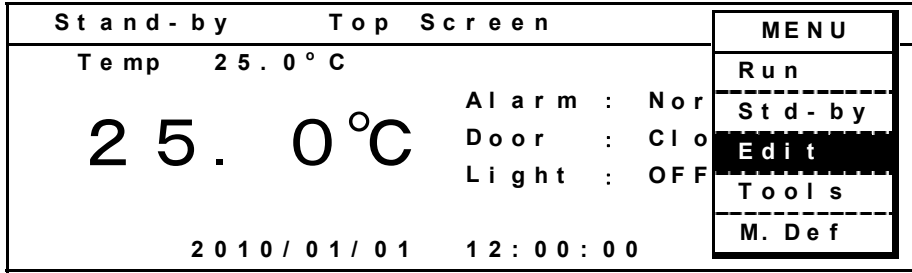

2. The saved programs are shown. Select a program (for example: Oze) to edit, and press the menu button (MENU). The menu window is opened. Select "OK", and press the enter key (ENTER).

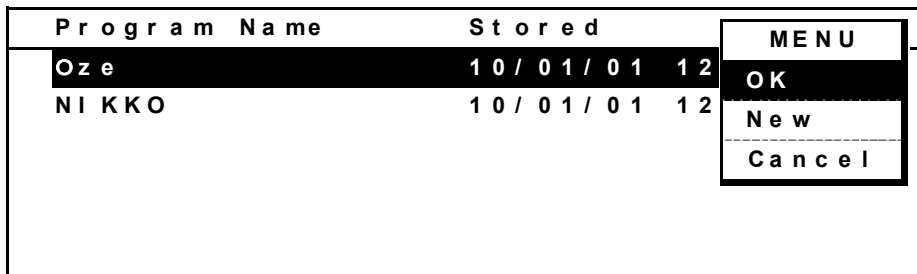

3. The program "Oze" is displayed. After changing the setting, press the menu button (MENU) to show the menu window. Select "Save", and press the enter key (ENTER).

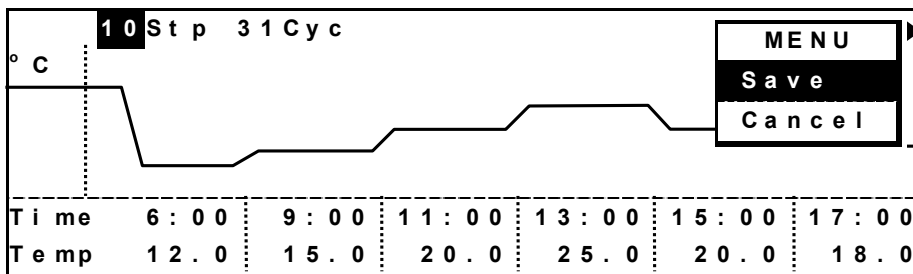

4. Save Program screen is opened. Input program name, and press the menu button (MENU) to show the menu window. Select "Save" when saving by overwriting, or select "SaveAs" when saving with another program name. Press the enter key (ENTER). The edited program is entered. Do not select "SaveAs" with same program name as another program.



START OF PROGRAM (MENU/Run)

1. With the top screen displayed, press the menu button (MENU) to show the menu window. Select "Run", and press the enter key (ENTER).

Stand-by Top Screen		MENU
Temp 25.0°C	Alarm : Nor	Run
25.0°C	Door : Clo	Std-by
	Light : OFF	Edit
2010/01/01	12:00:00	Tools
		M. Def

2. Program Name Stored screen is opened. Select "Oze" and press the menu button (MENU) when starting "Oze" program. Select "OK" on the menu window, and press the enter key (ENTER).

Program Name	Stored	MENU
Oze	10/01/01 12	OK
NIKKO	10/01/01 12	Cancel

3. Start Options screen is opened. On this screen, setting of Timer (selection of Clock mode or Timer mode), Join (Joining some programs), and start date is available. As the "Oze" is for clock mode, select 1 (Clock) for Timer. For join, select 2 (No : not join) since the Oze does not have joined program. Input the start date (Ex.2010 01 01) and time (Ex.12:30:00), and press the menu button (MENU) to show the menu window. Select "OK", and press the enter key (ENTER).

Start Options		MENU
Timer	1 (1. Clock 2. Dec)	OK
Join	2 (1. Yes 2. No)	Cancel
Start at		
Date	10/01/01 (YY/ MM/ DD)	
Time	12:30:00 (hh: mm: ss)	

■ Timer (selection of Clock mode or Timer mode)

1. Clock (Clock mode): Displays start time of each steps.
2. Dec (Timer mode): Displays the remaining time up to a next step.

■ Join (Joining some programs)

Join 1.Yes: The joined programs are operated when a selected program is set as a join program. Refer to page 30 for details.

■ Start at (desired start date)

Date and time when the window is opened is displayed. Input the desired start date and time.

START OF PROGRAM (MENU/Run)

4. The selected program is displayed. Check the program and press the menu button (MENU) to show the menu window. Select "Start", and press the enter key (ENTER).

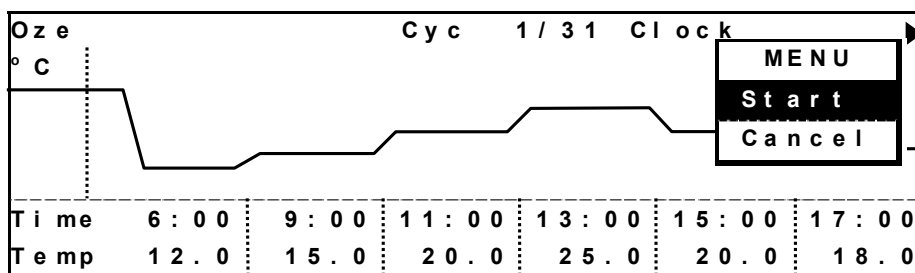

5. The program is started at desired date and time. During the programmed running, the graphic screen as below is displayed. To change the graphic screen to the top screen, press the menu button (MENU) to show the menu window. Select "Top" and press the enter key (ENTER). To change to the graphic screen, press the menu button (MENU) to show the menu window. Select "Graph" and press the enter key (ENTER).

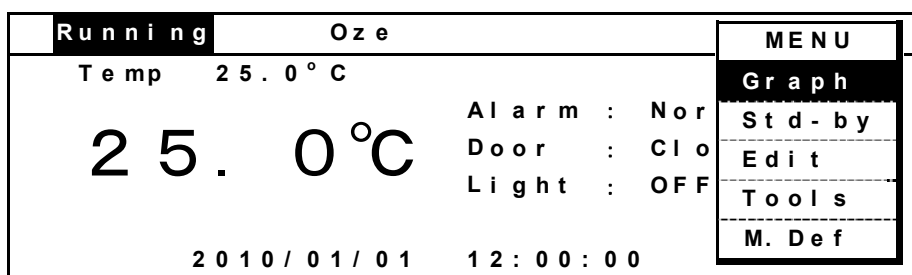
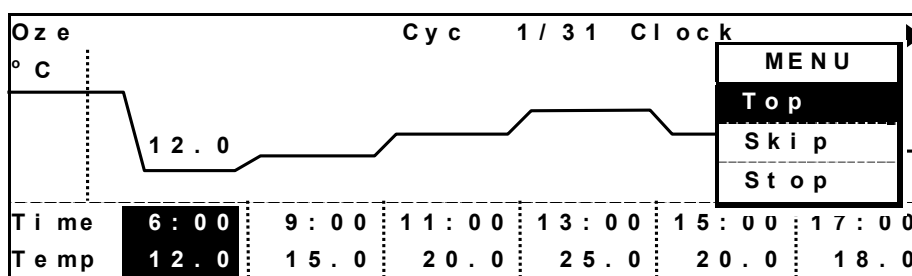

When the starting time of program operation is later, "Waiting" is displayed in the current running status of LCD panel.

JOIN FUNCTION

This product has join function to run several programs continuously. The maximum programs to be joined are 9. The setting of join function is as follows:

1. When joining three programs Spring, Summer and Autumn, input the same character string, # and one digit figure (joined order) before the each program name. Each program operates as a special program for join function. Any character or figure is permitted for a string on the top. The programs cannot be joined when the character string is not same.

Note: The characters after one digit figure have no effect on the join function.

Ex.1: When joining the programs Spring, Summer and Autumn in this order and top character string is "Oze" the input for the join function is as follows:

Oze#1 Spring Oze#2 Summer Oze#3 Autumn

Ex.2: When joining in the order of Autumn, Spring and Summer in this order and input "NIKKO" as the same character string, the input for the join function is as follows:

NIKKO#1 Autumn NIKKO#2 Spring NIKKO#3 Summer

2. When running the joined program in Ex.1, select the program Oze#1 Spring on the Program Name Stored screen in MENU/Run (Refer to page 28).

Note: The program Oze#2 Summer is selected, the program Oze#2 Summer and Oze#3 Autumn are performed. Oze#1 Spring is not joined.

3. Select 1.Yes for the join function on the Start Options screen. Press the menu button (MENU) to show the menu window. Select "OK" and press the enter key (ENTER).

Note: The joined function is not effective if select 2. No on the Start Options screen.

4. Press the menu button (MENU) to show the menu window. Select "Start" and press the enter key (ENTER). The joined program is started.

5. Running result

Run in the order of Oze#1 → Oze#2 → Oze#3. During the running of joined program, "Join" is displayed at the upper right on the screen.

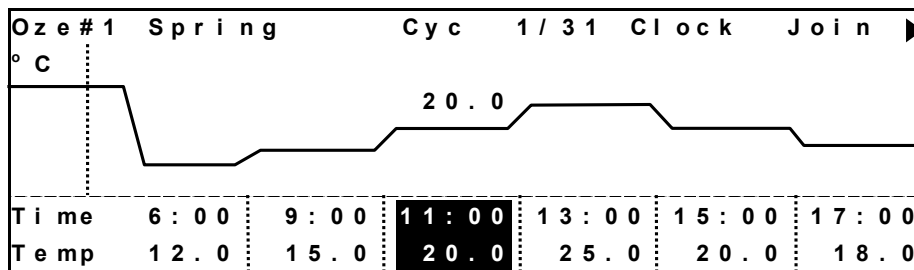

SKIP OF STEP (MENU/Skip)

During the programmed running, the skip function is effective to skip a current step in the program.

1. Press the menu button (MENU) to show the menu window and select "Graph" when the top screen is displayed. Then press the enter key (ENTER).
2. Press the menu button (MENU) under program running and the menu window is opened. Select "Skip", and press the enter key (ENTER).

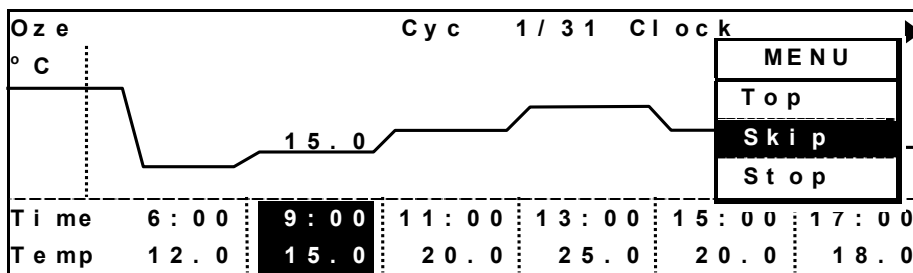

3. The Confirmation screen is displayed. Press the menu button (MENU). Selecting "Next" causes the skip to the next step. Selecting "Back" causes the skip to the previous step. After selecting "Next" or "Back", press the enter key (ENTER).

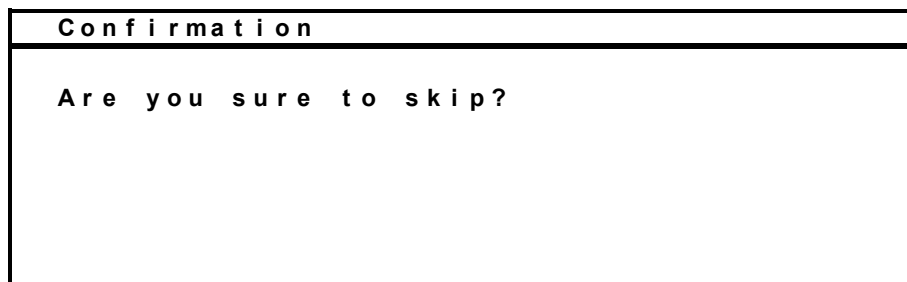

4. Programmed running shifts to next step and programmed running continues.

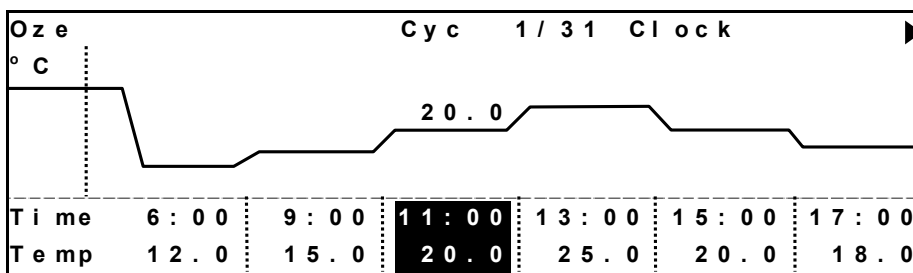

STOP OF PROGRAM (MENU/Stop)

During the programmed running, it is possible to stop the running at any step.

1. During the programmed running, press the menu button (MENU) to show the menu window and select "Graph" when the top screen is displayed. Then press the enter key (ENTER).
2. Press the menu button (MENU) under program running and the menu window is opened. Select "Stop", and press the enter key (ENTER).

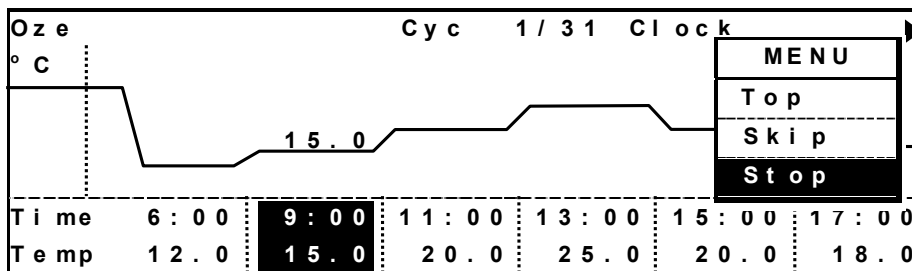

3. The Confirmation screen is displayed. Press the menu button (MENU). Selecting "OK" and press the enter key (ENTER) to stop the program.



4. After stopping the program, the top screen is displayed.

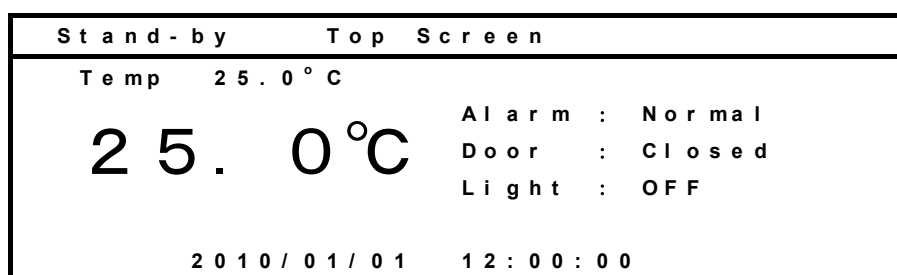

AUTOMATIC DEFROST (MENU/Tools/Date Time)

This product has a frost check opening to check amount of the frost on the evaporator that lowers temperature in a chamber. Automatic defrost function defrosts the frost on the evaporators automatically at the specified time everyday. Default setting is 0(Manual).

1. Press the menu button (MENU) to show the menu window and select "Tools" when the top screen is displayed. Then press the enter key (ENTER).

2. Select "Date Time" on the Select Tools screen, and press the menu button (MENU) to show the menu window. Select "OK" and press the enter key (ENTER).

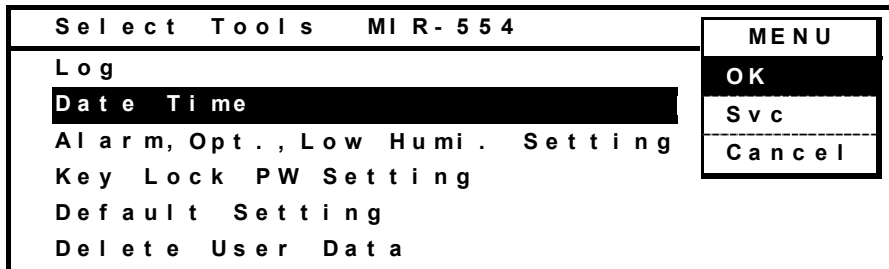

3. The Date Time screen is displayed. Select the Def Timer (Automatic defrost function) 0 (Manual) or 1 (Auto). When selecting 0 (Manual), automatic defrosting is not done. When selecting 1 (Auto), it is possible to set the time to defrost automatically in every one hour between 0:00 and 23:00. (The figure below shows that the defrost starts at 3:00.)

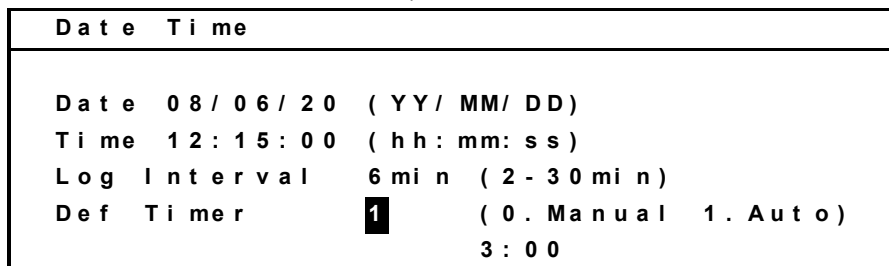

CAUTION

Automatic defrosting is activated even in programmed running, and the chamber temperature may arise due to the amount of the frost existing on the evaporator. In this case, manual defrosting is recommended.

CAUTION

During defrosting, "Defrosting" is displayed on running status of LCD panel.

During defrosting, the chamber temperature deviates from the set temperature (The chamber temperature raise by approximately 2 °C with the setting temperature of 5 °C under ambient temperature of 30 °C and humidity of 80 %R.H.)

Care should be taken for deviation of setting and current temperature during defrosting. In case of long term running of setting temperature below 5 °C, expected running will be failed due to frost.

Defrosted water will be evaporated automatically outside of the chamber.

●Defrosting is likely not to operate when the inner temperature is over 5 °C.

●Frost will exist on the evaporator when temperature setting is below 5 °C. Frost-clogged evaporator causes insufficient cooling and inner temperature rising. When a lot of frost existed on the evaporator is seen through the frost check opening, immediate defrosting is required. Frosting on the evaporator is accelerated when moisturized material is put inside the chamber.

MANUAL DEFROST (MENU/M.def)

The manual defrost function is for defrosting the frost on the evaporator at any time. When a lot of frost on the evaporator is found, start the manual defrost. Besides this function, it is possible to set the automatic defrost function. (Refer to page 33)

1. Press the menu button (MENU) to show the menu window. Select "M.Def" and press the enter key (ENTER).

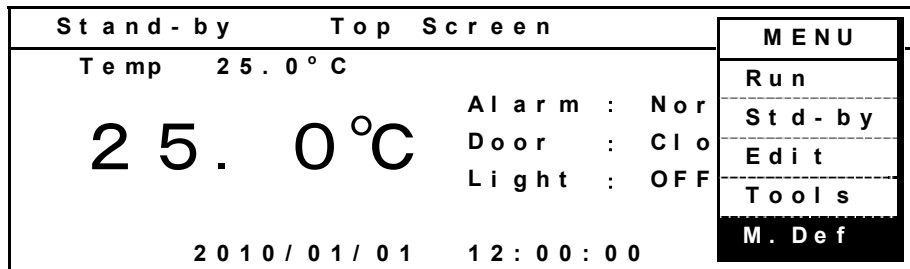

2. The Confirmation screen is displayed.

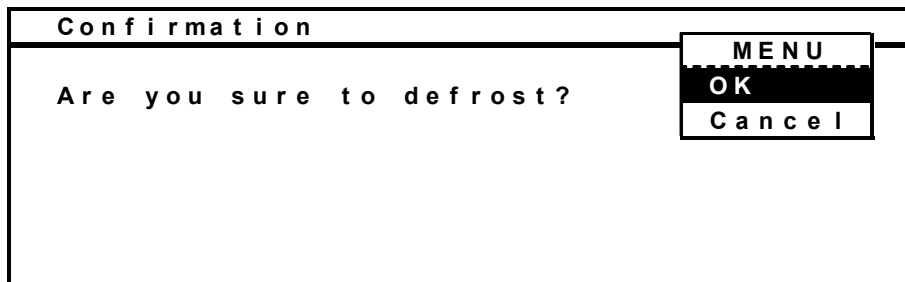

3. Press the menu button (MENU) to show the menu window. Select "OK", and press the enter key (ENTER). The manual defrost is started. During defrosting, "Defrosting" is displayed at the upper left on the top screen.

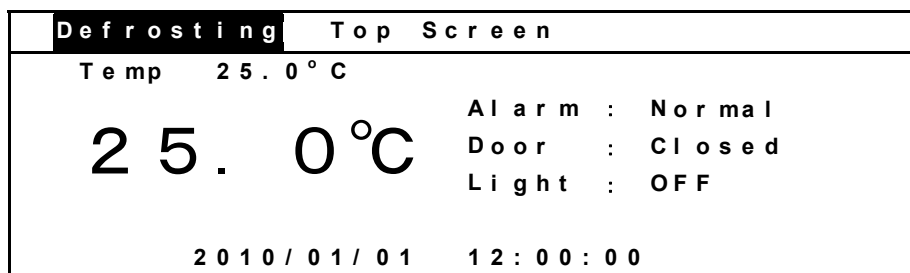

CAUTION

The manual defrost can be started during programmed running, standby operation, or automatic defrosting.

4. The manual defrost is finished automatically. The defrosting time depends on the amount of frost on the evaporator.

VARIOUS SETTING (MENU/Tools)

The log can be displayed and various setting can be changed by using "Tools" menu.

1. Press the menu button (MENU) with the top screen to show the menu window. Select "Tools", and press the enter key (ENTER).

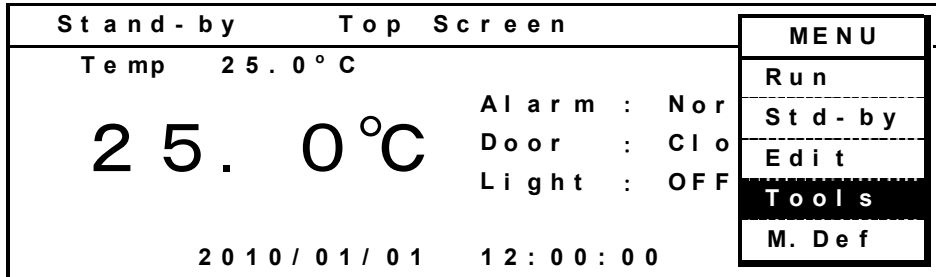

2. The Select Tools screen is as follows.

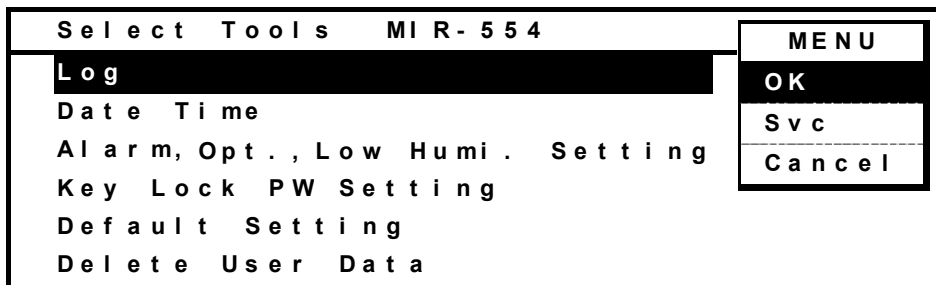

Display of log (Tools/Log)

1. Select "Log" in the Select Tools screen. Press the menu button (MENU) to show the menu window. Select "OK", and press the enter key (ENTER).

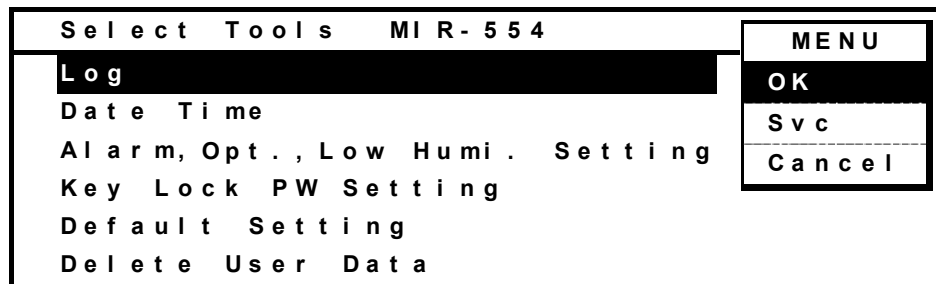

2. The log is presented with dot. By pressing the upward shift key or downward shift key, the log to be displayed is changed; temperature and light step. The displayed date is scrolled by pressing the leftward or rightward shift key. (leftward shift key; older date, rightward shift key; newer date.)

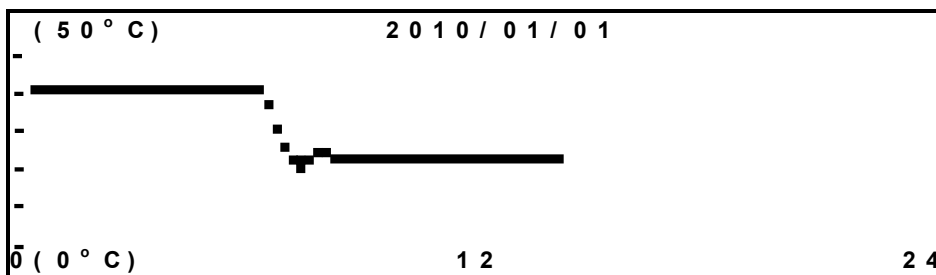

VARIOUS SETTING (MENU/Tools)

3. The display area (upper and lower limit) can be changed. Press the menu button (MENU) to show the menu window. Select "Range2" and press the enter key (ENTER). Upper limit is changed from 50 °C to 60 °C and lower limit is changed from 0 °C to -10 °C.

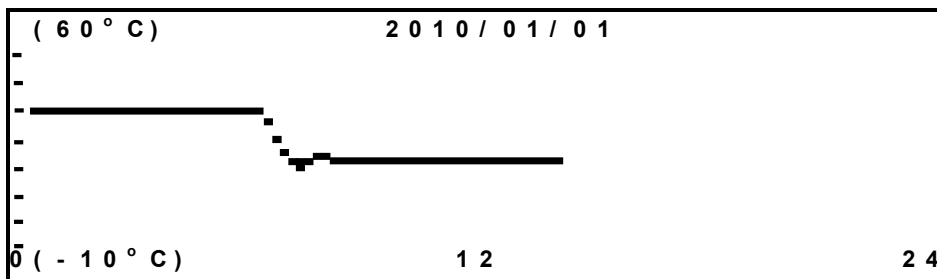
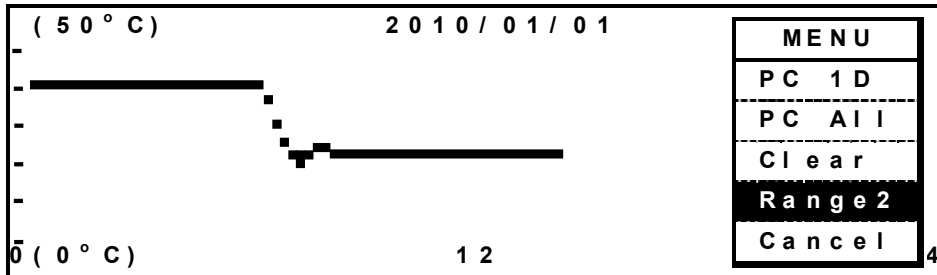

Similarly, select "Range1" and press the enter key (ENTER). Upper limit is changed from 60 °C to 50 °C and lower limit is changed from -10 °C to 0 °C.

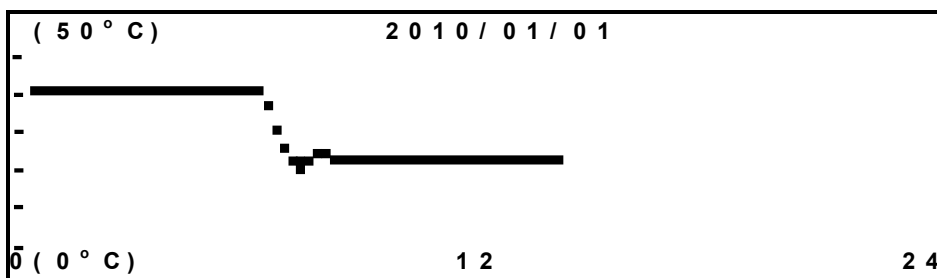
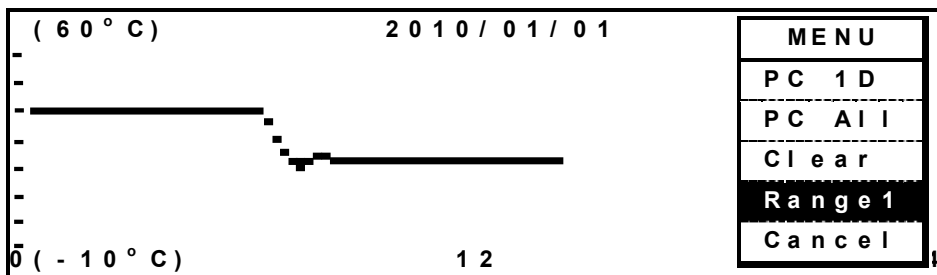

VARIOUS SETTING (MENU/Tools)

Data transmission

The procedure to transmit the log data to a PC is as follows.

1. Press the menu button (MENU) to show the menu window. Select "PC 1D", and press the enter key (ENTER) when the log for one day is necessary. Select "PC All", and press the enter key (ENTER) when all data recorded is necessary.

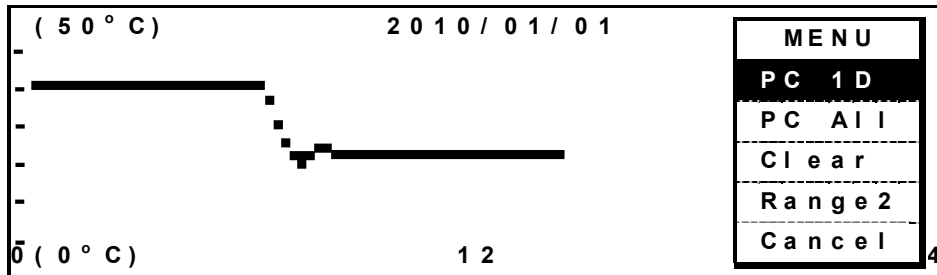

2. The Progress screen is displayed. Specify a transfer, capture of text and retention file name by operation of hyper terminal on PC. Apply "txt" or "csy" to retention file as an extension. Press the menu button (MENU) to show the menu window. Select "Start", and press the enter key (ENTER). The transmission is started. "Finished" display means the end of transmission.

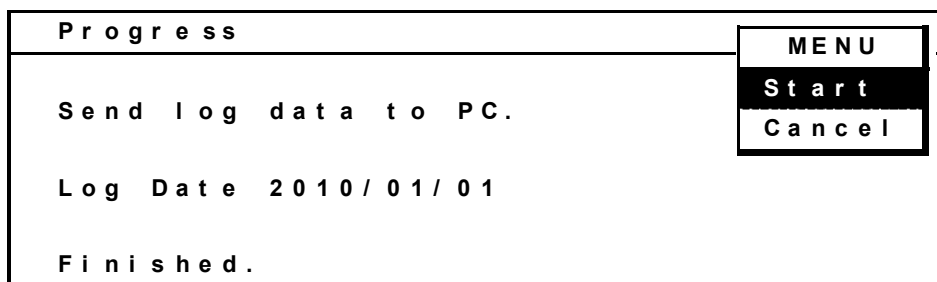

Setting in PC side for transmission of log data (For Windows 2000 and Windows XP)

1. From start button, start the hyper terminal (start button → program → accessory → communication -hyper terminal).
(when not registered in the start menu, C:¥Program Files¥Windows NT¥hypertrm.exe)
2. Through the hyper terminal display, set new connection, name (for example: Matsushita), setting of connection, method of connection, COM1, property of COM1 and port.
bit/sec; 9600, data bit; 8, parity; no, stop bit; 1, flow control; Xon/Xoff.
(Communicating condition of MIR side is set as above automatically when the Progress screen is displayed.)

Note:

For the data transmission, an optional interface board MTR-480 and communication cable of 9 pin Dsub cross type for RS232C are necessary.
Consult our sales representative or agent at the time of installation of the optional parts.

VARIOUS SETTING (MENU/Tools)

Setting of date, time, log (Tools/Date Time)

1. Select "Date Time" in the Select Tools screen. Press the menu button (MENU) to show the menu window. Select "OK", and press the enter key (ENTER).

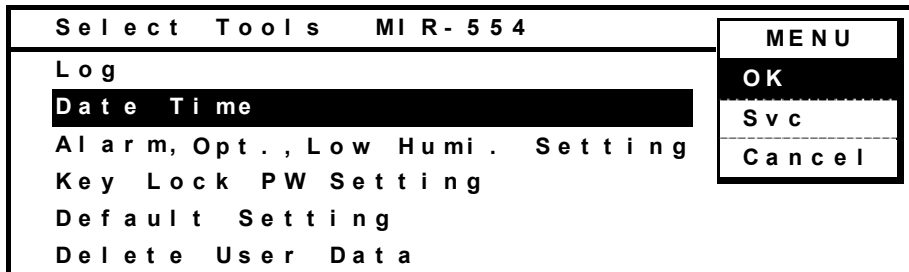

2. The Date Time screen is displayed. Set date, time or log cycle.

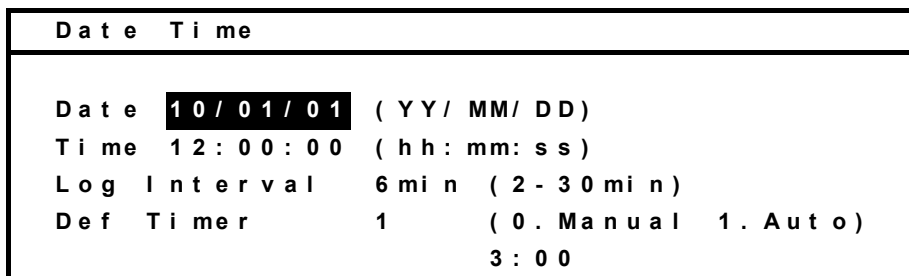

- Date input (Ex: Feb. 14, 2010)
Input 100214 in the date cell.

- Time input (Ex: 12:15:00)
Input 121500 in the time cell.

- Log cycle input (Ex: 6 minutes)
Input 6 in log Interval cell.

Note:

- The default is 6 minutes.
 - The acceptable range is between 2 and 30 minutes.
 - Relation between the log interval and spans that can be memorized
- | | |
|------------------------|---------------|
| 1: Log interval 2 min | About 5 days |
| 2: Log interval 6 min | About 14 days |
| 3: Log interval 30 min | About 70 days |

After passing the memory limit, the older data is deleted and newer data is memorized.

- Setting of automatic defrost

Select one of two defrosting patterns. The default is 0(Manual defrost). For the details of defrost, refer to page 33~34.

0: Manual defrost

1: Automatic defrost

VARIOUS SETTING (MENU/Tools)

Alarm setting (Tools/Alarm, Opt., Low Humi. Setting)

1. Select "Alarm, Opt., Low Humi. Setting" in the Select Tools screen. Press the menu button (MENU) to show the menu window. Select "OK", and press the enter key (ENTER).

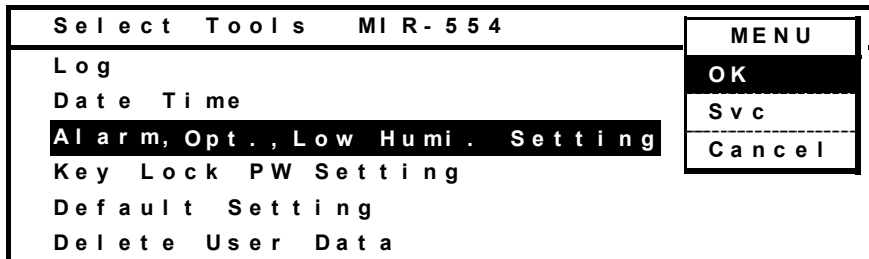

2. The Alarm, Option, Low Humidity Setting screen is displayed. On this screen, the temperature alarm (Temp Alarm), delay time of alarm (Alarm Delay), alarm resume time (Ring Back) and lamp (Lamp) can be set. The alarm buzzer is silenced by pressing the alarm buzzer stop key (BUZZER) during alarm condition. The buzzer will be activated again after certain suspension if the alarm condition continues. The suspension time (ring back) can be set.

Alarm, Option, Low Humidity Setting	
Temp Alarm	±2.5 °C (±1.0 °C - ±5.0 °C)
Alarm Delay	15 min (0 - 15 min)
Ring Back	30 min (0. OFF 1 - 99 min)
Inner Door	0 (0. Normal 1. Option)
Lamp	0 (0. Normal 1. Option)
Low Humidity Mode	0 (0. No 1. Yes)

The settable range:

- Temperature alarm (Temp Alarm): ±1.0 °C~±5.0 °C.
- Delay time of alarm (Alarm Delay): 0 minute~15 minutes.
- Suspension time (Ring Back): 1 minute~99 minutes, or OFF

3. When optional inner door (MIR-55ID) is installed, set the inner door (Inner Door) to 1.
 - When the inner door is installed, the set temperature is limited under 50 °C.
 - The inner door might be damaged by running at the temperature that exceeds 50 °C as the setting of the inner door (Inner Door) is 0.

4. When optional light add on kit (MIR-L15) is installed, set the lamp (Lamp) to 1.
 - When optional light add on kit (MIR-L15) is installed, except when the set value of temperature is between +2 °C~+50 °C, the lighting is turned off. The set value of temperature is limited between +2 °C ~+50 °C after Lamp is set to 1.

5. The condensation in the chamber is reduced by running control with the set temperature between +20 °C and +40 °C when the low humidity mode (Low Humidity Mode) is set to 1.
 - The condensation can be found on the inside of the door or clearance in the chamber when running in humid chamber status without low humidity mode (Low Humidity Mode is set to 0).

CAUTION

It is not possible to change the delay time of door alarm, 2 minutes only. When door is open, "Open" is displayed on the top screen.

VARIOUS SETTING (MENU/Tools)

Key lock password setting (Tools/Key Lock PW Setting)

1. Select "Key Lock PW Setting" in the Select Tools screen. Press the menu button (MENU) to show the menu window. Select "OK" and press the enter key (ENTER).

Select Tools MIR-554	MENU
Log	OK
Date Time	Svc
Alarm, Opt., Low Humi. Setting	Cancel
Key Lock PW Setting	
Default Setting	
Delete User Data	

2. Input the Current User Password (4 digits). Select "OK" and press the enter key (ENTER).
The default User Password when shipped from the factory is "0000".

Key Lock PW Setting
Current User Password [REDACTED]

3. Input New User Password (4 digits). Select "OK" and press the enter key (ENTER).

Key Lock PW Setting
New User Password [REDACTED]

4. Input User Password (4 digits) again. Select "OK" and press the enter key (ENTER).

Key Lock PW Setting
New User Password ****
Re Enter User Password [REDACTED]

Note: Consult our sales representative or agent if you put off the password.

VARIOUS SETTING (MENU/Tools)

Default setting (Tools/Default Setting)

1. Select "Default Setting" in the Select Tools screen. Press the menu button (MENU) to show the menu window. Select "OK", and press the enter key (ENTER).

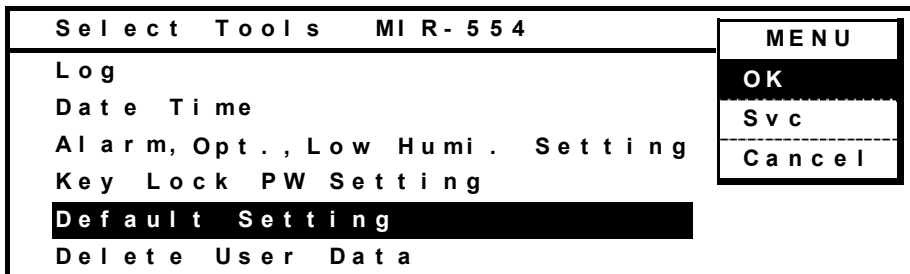

2. The Default Setting screen is displayed. Set the default for each parameter as necessary.

Default Setting		
LCD Back Color	1	(1. Blue 2. White)
DAQ Speed	0	(0. 2400 2. 9600)
DAQ ID	0	(0. OFF 1- 250)
DAQ Mode	0	(0. Local 1. Remote)
Buzzer Finished	1	(1. Yes 2. No)
Analog Range	0	(0. Normal 1. Wide)

LCD Back Color: Setting of background color (1. Blue 2. White)

Buzzer Finished: Select of buzzer activation (1: Yes) or no activation (2: No) at the time of completion of a programmed running. (The buzzer activates 6 times when a program is finished.)

Analog Range: Select of analog output range of temperature in chamber (0: 0°C~50°C 1: -20°C~80°C)

Note:

DAQ is an external monitoring system of chamber status. It is necessary to set the DAQ Speed, DAQ ID and DAQ Mode when using communication software. Communication software is ordered specially consult our sales representative or agent.

VARIOUS SETTING (MENU/Tools)

Delete of program (Tools/Delete User Data)

1. Select "Delete User Data" in the Select Tools screen. Press the menu button (MENU) to show the menu window. Select "OK", and press the enter key (ENTER).

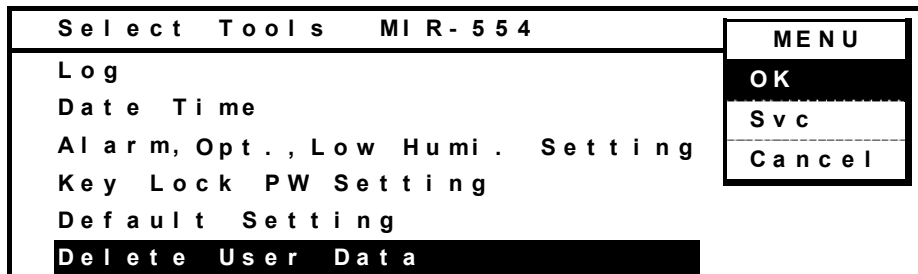

2. The Delete User Data screen is displayed. To select a program to delete, select "Delete a User Program" and press the menu button (MENU) to show the menu window. Select "OK" and press the enter key (ENTER).

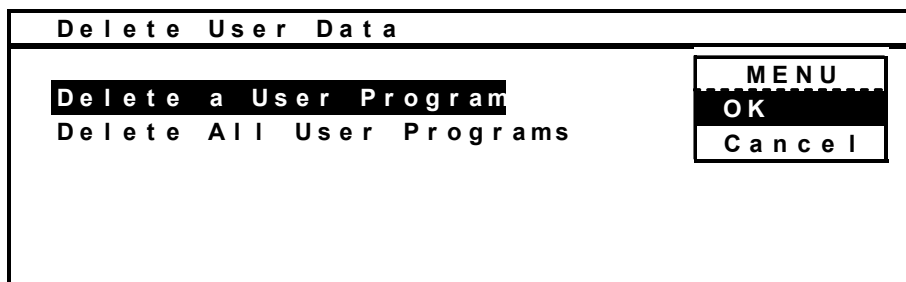

3. A list of saved programs is displayed. Select a program (Ex: Oze#1 Spring) to delete, press the menu button (MENU) to show the menu window. Select "Delete" and press the enter key (ENTER).

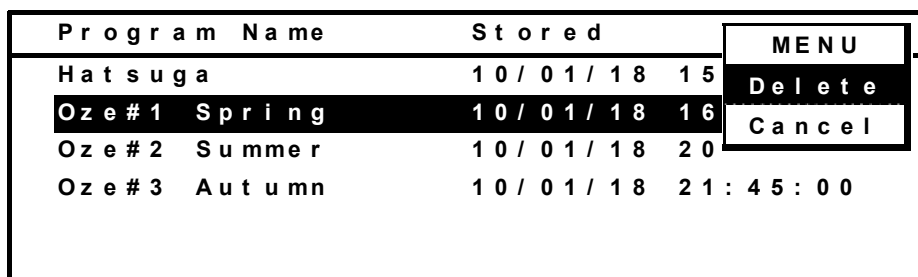

4. The Confirmation screen is displayed. Press the menu button (MENU) to show the menu window. Select "OK", and press the enter key (ENTER). The program (Oze#1 Spring) is now deleted.

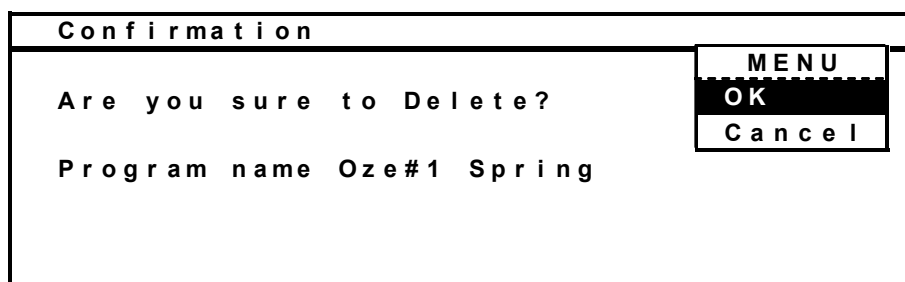

VARIOUS SETTING (MENU/Tools)

5. To delete all programs, select "Delete All User Programs" in Delete User Data screen and press the menu button (MENU) to show the menu window. Select "OK" and press the enter key (ENTER).

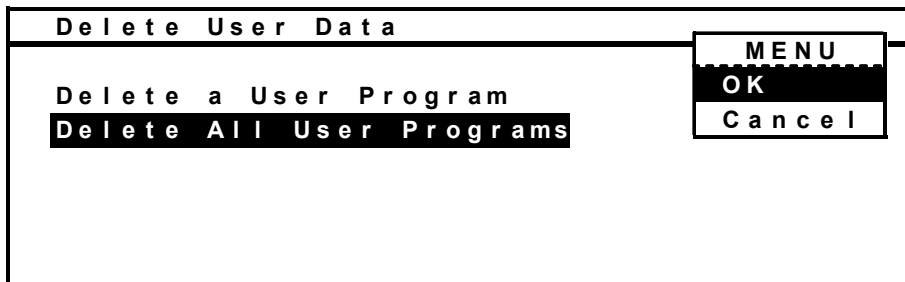

6. The Confirmation screen is displayed. Press the menu button (MENU) to show the menu window. Select "OK", and press the enter key (ENTER). All of the programs are now deleted.

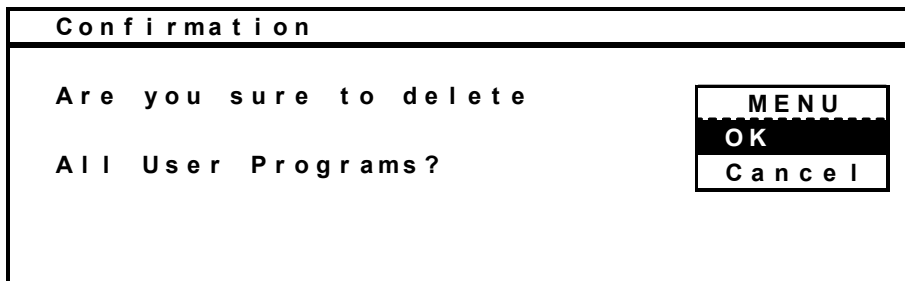

ADJUSTMENT OF SHELVES

The interval between the shelves can be adjusted depending on the height of the stored items. To install the shelves, insert the clip to the desired location.

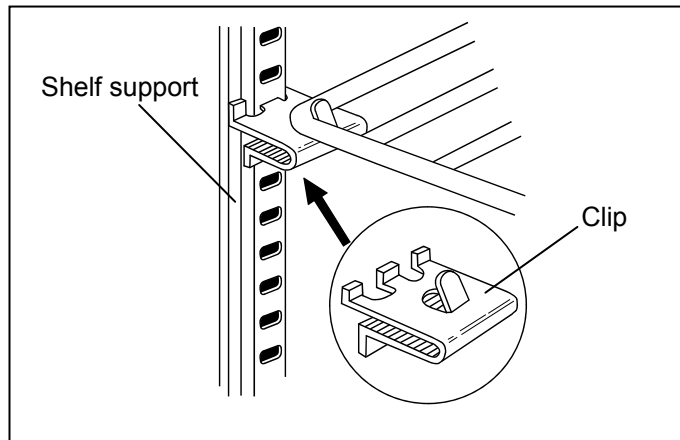

Note:

- The chamber is refrigerated by the forced circulation of cooled air inside the chamber. Ensure that the intake and exhaust vents are not blocked. Blocking these vents cause deviation of chamber temperature from the set temperature.
- Always install the stainless plate on the bottom shelf. The operation without this plate makes the temperature distribution worse.
- Do not store any materials that can generate the corrosive gas such as sulfureted gas or gaseous chlorine in the chamber. The corrosive gas may cause failure of the products.

ALARMS AND SAFETY FUNCTIONS

The unit has the alarms and safety function as shown in the table 1 below.

Table 1 Alarms and safety functions

Alarm	Condition	Display	Buzzer	Remote contact	Safety operation
Auto-set temp. alarm	When the chamber temp. deviates from set temp. by more than 2.5 °C. (± 1.0 °C ~5.0 °C changeable)	<Top screen> The current chamber temp. blinks.	Intermittent tone with delay	Alarm status with delay	High stage side; heater OFF Low stage side; compressor OFF
Upper limit alarm	When the chamber temp. is higher than the upper limit temp.	—	Continuous tone	Alarm status	Heater, fluorescent lamp, fan motor OFF
Lower limit alarm	When the chamber temp. is lower than the lower limit temp.	—	Continuous tone	Alarm status	Compressor OFF
Thermal fuse	When the chamber temp. is over 70 °C	—	—	—	Main heater and sub-heater OFF
Thermal sensor abnormality	Input voltage is over 70 °C corresponding Input voltage is lower than -50 °C corresponding	<Top screen> “E01:Temp. sensor is opened.” “E02:Temp. sensor is shorted.”	Intermittent tone	Alarm status	Heater, fluorescent lamp, fan motor and compressor OFF
Abnormal completion of defrosting	The temp. control sensor is higher than 20 °C during defrosting	<Top screen> “E03:Abnormal completion of defrosting.”	—	—	Forced finish of defrosting
Short-circuit of SSR or compressor relay	Microcomputer determines triac/compressor relay is shorted	<Top screen> “E04:SSR or comp. relay is shorted.”	Intermittent tone	Alarm status	—
Disconnection of SSR	The heater is not energized	<Top screen> “E05:SSR is open-circuited.”	Intermittent tone	Alarm status	—
Disconnection of compressor relay	The compressor relay is not energized	<Top screen> “E06:Comp. relay is open-circuited.”	Intermittent tone	Alarm status	—
Buzzer delay	Under condition of auto-set temp. alarm (delay time; changeable)	—	—	—	—
Back-up of program	During power failure	—	—	—	Nonvolatile memory Continuous running after recovery from power failure

ALARMS AND SAFETY FUNCTIONS

Alarm	Condition	Display	Buzzer	Remote contact	Safety operation
Back-up of clock function	During power failure	—	—	—	Continuous running by battery (CR2032)
Fan lock	Fan is locked	<Top screen> “E07:Air circulating fan motor trouble.”	Intermittent tone	Alarm status	Compressor OFF and heater OFF
Protection of compressor	The protective sensor is higher than 90 °C	<Top screen> “E08:Comp. is over-heat.”	Intermittent tone	Alarm status	—
Time to replace the fan motor	The running time is over 60,000 hours	<Top screen> “Warning:Replace air circulating fan mot.”	—	—	—
Disconnection of compressor protective sensor	The input voltage corresponds to -50 °C or less disconnection of sensor	<Top screen> “E09:Comp.sensor is opened.”	Intermittent tone	Alarm status	Compressor OFF
Defrost sensor abnormality	The input voltage corresponds to -50 °C or less disconnection of sensor	<Top screen> “E10:Def.sensor is opened.”	Intermittent tone	Alarm status	Heater OFF
	The input voltage corresponds to 70 °C or more short of sensor	<Top screen> “E11:Def.sensor is shorted.”	Intermittent tone	Alarm status	Heater OFF
Time to replace the fan motor for compressor	The running time is over 42,000 hours	<Top screen> “Warning:Replace comp. cooling fan motor”	—	—	—
Door alarm	Door is open for 2 minutes.	<Top screen> “Door:Open”	Intermittent tone with delay	—	Heaters, fan motor OFF
Power failure alarm	At power failure. If the power supply cord is unplugged or the power switch is turned off.	—	—	Alarm status	—

ALARMS AND SAFETY FUNCTIONS

The auto-set temperature alarm function is fitted in the temperature controller. The alarm is activated automatically when the chamber temperature deviates ± 2.5 °C (± 1.0 °C \sim ± 5.0 °C) from the set temperature.

This temperature alarm function is set automatically even if under the program operation. The alarm is activated as follows under program operation.

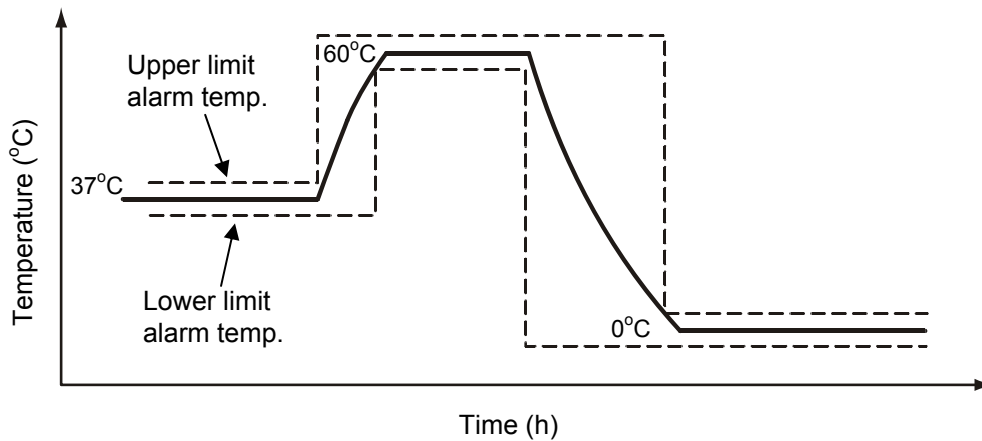

* The buzzer is stopped by pressing the alarm buzzer stop key (BUZZER), but the remote alarm keeps alarm status. The buzzer resulting from upper limit alarm and lower limit alarm cannot be silenced by the alarm buzzer stop key (BUZZER).

* The alarm may be activated when the setting of auto-set temperature alarm is small range.

MAINTENANCE

WARNING

Always disconnect the power supply to the unit prior to any repair or maintenance of the unit in order to prevent electric shock or injury.

Ensure you do not inhale or consume medication or aerosols from around the unit at the time of maintenance. These may be harmful to your health.

Cleaning

- Clean the unit once a month. Regular cleaning keeps the unit looking new.
- Use a dry cloth to wipe off small amounts of dirt on the outside and inside of the unit and all accessories. If some of them are dirty, use a cloth containing diluted neutral dishwashing detergent (Undiluted detergent may break the plastic parts. For the dilution, follow the instruction enclosed with the detergent). When a diluted neutral dishwashing detergent is used, wipe the cabinet or accessories thoroughly with a cloth soaked in clean water. Then wipe the cabinet or accessories unit with a dry cloth to eliminate the moisture.
- Never pour water onto or into the unit. Doing so can damage the electrical insulation and may cause electric shock or short circuit.
- The compressor and other mechanical part are completely sealed. This unit requires absolutely no lubrication.
- Wipe off the condensation on the outside frame or glass with a soft dry cloth.

● **CAUTION**

Do not use brushes, acids, thinners, powdered soap or hot water for cleaning the incubator. Polishing powders or hot water can deteriorate the painted surfaces or cause deformation, discoloration or degeneration of plastic or rubber components. Be especially careful not to wipe plastic or rubber parts with volatile solvents such as benzene.

MAINTENANCE

Cleaning of evaporating tray

The evaporating tray is located at lower side on the front. Clean the evaporating tray twice or three times per year with water. Before removing the evaporating tray, wipe off the water in it. The procedure to remove is as follows:

1. Remove 2 black screws fixing the evaporating tray at the bottom of the front frame.
2. Pull out the evaporating tray 3 cm toward you horizontally to avoid the spillage of the water. Take care not to damage the evaporating pipe.
3. Slide out the evaporating tray on the floor after touching to the floor.
4. To replace the evaporating tray, follow the procedure in reverse.

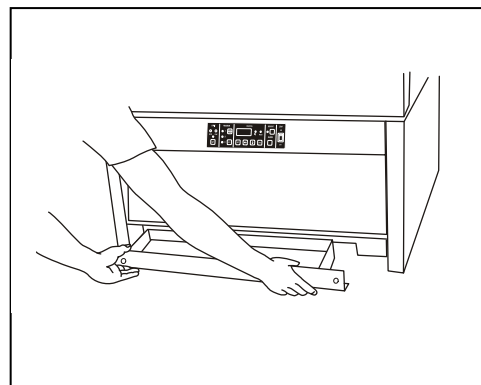
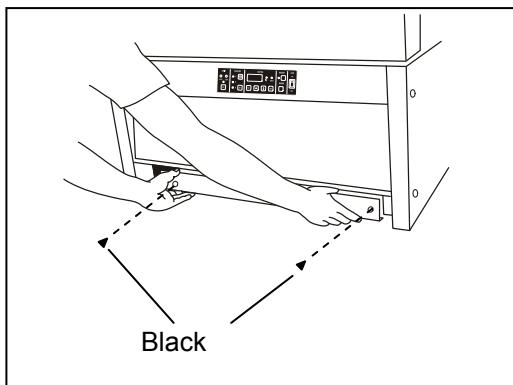

Note: Consult our sales representative or agent when cleaning the evaporating tray.

Replacement of lamp

Turn off the power switch and disconnect the power supply plug from the outlet.

1. Remove 2 screws fixing the shade by using a screw driver as shown in the figure.
 2. Pull the lamp downward with lead wire connected.
 3. Install a new lamp in the cover and adjust the lamp direction according to the socket terminal.
 4. Replace the shade and fix it with 2 screws.
- The lamp is consumable. (type:FL-15D)

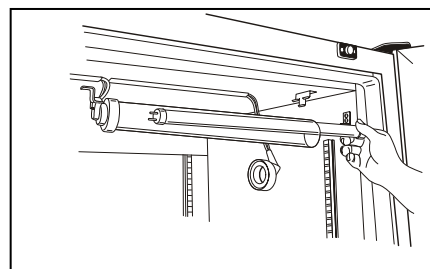
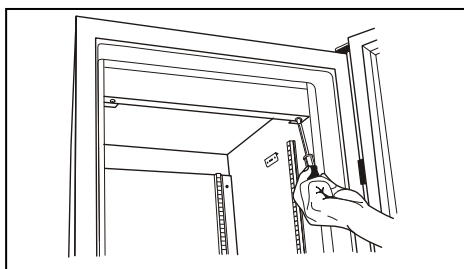

Note: Consult our sales representative or agent when replacing the lamp.

MAINTENANCE

Replacement of glow starter

The glow starter is located at the switch box on the lower right side.

1. Turn off the power switch and disconnect the power supply plug from the outlet.
 2. Turn the glow starter to counter clockwise to remove. (See figure below)
 3. Set a new glow starter. (type: FG-1P)
- The glow starter is consumables. Please replace the glow starter at the same time with the lamp.

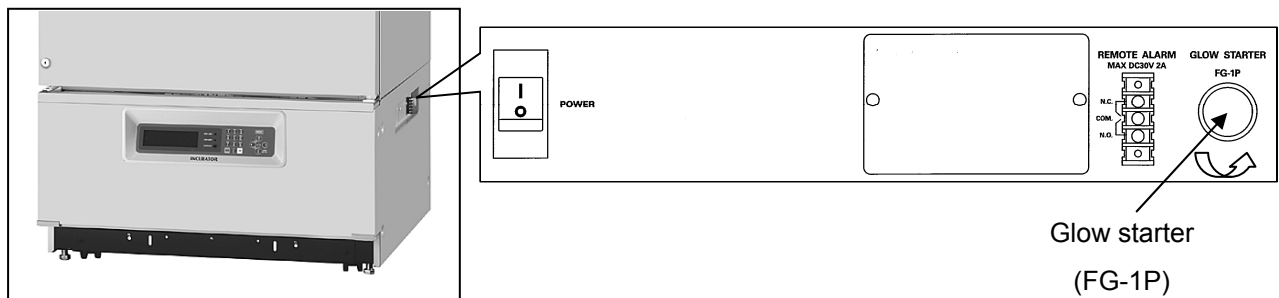

Replacement of glow starters (Optional light add on kit MIR-L15)

The glow starters of optional light add on kit (MIR-L15) are located inside the unit cover on the lower left side.

1. Turn off the power switch and disconnect the power supply plug from the outlet.
 2. Remove 4 screws fixing the unit cover by using a screw driver.
 3. Turn the glow starter to counter clockwise to remove. (See figure below)
 4. Set new glow starters. (type: FG-1P)
- The glow starter is consumables. Please replace three glow starters at the same time with the lamps.

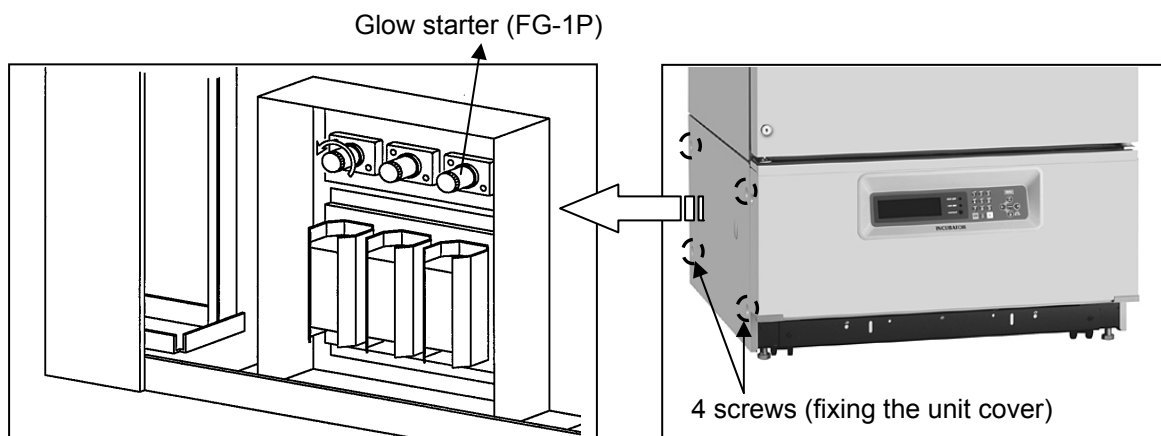

Note: Consult our sales representative or agent when replacing the glow starters.

TROUBLESHOOTING

If the unit malfunctions, check out the following before calling for service. In the case of no refrigeration or poor refrigeration, transfer the stored items to another incubator before checking out.

Malfunction	Check/Remedy
When the buzzer sounds continuously	<p>In the event of lower limit temperature alarm</p> <ul style="list-style-type: none"> ▪ The set temperature of the chamber is lower than the lower limit temperature. <p>The lower limit temperature should be lower than the set temperature by more than 5 °C.</p> <p>Set the lower limit temperature after actual temperature of chamber reaches to the set temperature of operation.</p> <p>In the event of upper limit temperature alarm</p> <ul style="list-style-type: none"> ▪ The set temperature of the chamber is higher than the upper limit temperature. <p>The upper limit temperature should be higher than the set temperature by more than 5 °C.</p> <p>Set the upper limit temperature after actual temperature of chamber reaches to the set temperature of operation.</p> <ul style="list-style-type: none"> ▪ The excessive heat source is in the chamber. <p>Remove the excessive heat source.</p> <p>For the allowable heat load, refer to the graphs on page 57.</p>
When the program operation does not function well	<p>The chamber temperature does not change according to the program.</p> <ul style="list-style-type: none"> ▪ The incubator performance (pull-up, pull-down) is not sufficient for the program setting. ▪ The over-heat or over-cool alarm temperature is wrong. <p>These temperatures should be set 5 °C higher and lower than the upper and lower limits of the temperature controller respectively. Once excessively high/low temperature limits have been determined, the operation temperatures cannot be changed significantly due to the existence of the limits for extremes of temperature. For this reason, the excessively high/low temperature limits should be set at a wide range when the program operation is set.</p>

Note:

If the malfunction is not eliminated after checking the above items, or the malfunction is not shown in the above table, contact our sales representative or agent.

DISPOSAL OF UNIT

⚠ WARNING

If the unit is to be stored unused in an unsupervised area for an extended period **ensure that children do not have access and doors cannot be closed completely.**

The disposal of the unit should be accomplished by appropriate personnel. Always remove doors to prevent accidents such as suffocation.

DISPOSAL OF UNIT

Note:

This symbol mark and recycle system are applied only to EU countries and not applied to the countries in the other area of the world.

Waste Electrical and Electronic Equipment (WEEE) Directive-2002/96/EC

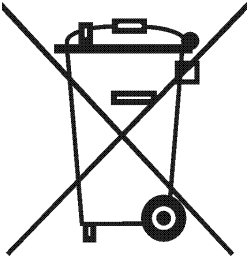

(English)

Your Panasonic product is designed and manufactured with high quality materials and components which can be recycled and reused.

This symbol means that electrical and electronic equipment, at their end-of-life, should be disposed of separately from your household waste.

Please dispose of this equipment at your local community waste collection/recycling centre.

In the European Union there are separate collection systems for used electrical and electronic products.

Please help us to conserve the environment we live in!

(German)

Ihr Panasonic Produkt wurde entworfen und hergestellt mit qualitativ hochwertigen Materialien und Komponenten, die recycelt und wiederverwendet werden können.

Dieses Symbol bedeutet, daß elektrische und elektronische Geräte am Ende ihrer Nutzungsdauer von Hausmüll getrennt entsorgt werden sollen.

Bitte entsorgen Sie dieses Gerät bei Ihrer örtlichen kommunalen Sammelstelle oder im Recycling Centre.

In der Europäischen Union gibt es unterschiedliche Sammelsysteme für Elektrik- und Elektronikgeräte.

Helfen Sie uns bitte, die Umwelt zu erhalten, in der wir leben!

DISPOSAL OF UNIT

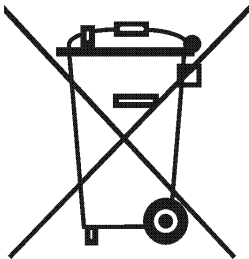

(French)

Votre produit Panasonic est conçu et fabriqué avec des matériaux et des composants de qualité supérieure qui peuvent être recyclés et réutilisés.

Ce symbole signifie que les équipements électriques et électroniques en fin de vie doivent être éliminés séparément des ordures ménagères.

Nous vous prions donc de confier cet équipement à votre centre local de collecte/recyclage. Dans l'Union Européenne, il existe des systèmes sélectifs de collecte pour les produits électriques et électroniques usagés.

Aidez-nous à conserver l'environnement dans lequel nous vivons !

Les machines ou appareils électriques et électroniques contiennent fréquemment des matières qui, si elles sont traitées ou éliminées de manière inappropriée, peuvent s'avérer potentiellement dangereuses pour la santé humaine et pour l'environnement.

Cependant, ces matières sont nécessaires au bon fonctionnement de votre appareil ou de votre machine. Pour cette raison, il vous est demandé de ne pas vous débarrasser de votre appareil ou machine usagé avec vos ordures ménagères.

(Spanish)

Los productos Panasonic están diseñados y fabricados con materiales y componentes de alta calidad, que pueden ser reciclados y reutilizados.

Este símbolo significa que el equipo eléctrico y electrónico, al final de su ciclo de vida, no se debe desechar con el resto de residuos domésticos.

Por favor, deposite su viejo "televisor" en el punto de recogida de residuos o contacte con su administración local.

En la Unión Europea existen sistemas de recogida específicos para residuos de aparatos eléctricos y electrónicos.

Por favor, ayúdenos a conservar el medio ambiente!

DISPOSAL OF UNIT

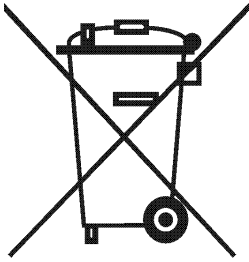

(Portuguese)

O seu produto Panasonic foi concebido e produzido com materiais e componentes de alta qualidade que podem ser reciclados e reutilizados.

Este símbolo significa que o equipamento eléctrico e electrónico no final da sua vida útil deverá ser descartado separadamente do seu lixo doméstico.

Por favor, entregue este equipamento no seu ponto local de recolha/reciclagem.

Na União Europeia existem sistemas de recolha separados para produtos eléctricos e electrónicos usados.

Por favor, ajude-nos a conservar o ambiente em que vivemos!

(Italian)

Il vostro prodotto Panasonic è stato costruito da materiali e componenti di alta qualità, che sono riutilizzabili o riciclabili.

Prodotti elettrici ed elettronici portando questo simbolo alla fine dell'uso devono essere smaltiti separatamente dai rifiuti casalinghi.

Vi preghiamo di smaltire questo apparecchio al deposito comunale.

Nell'Unione Europea esistono sistemi di raccolta differenziata per prodotti elettrici ed elettronici.

Aiutateci a conservare l'ambiente in cui viviamo!

DISPOSAL OF UNIT

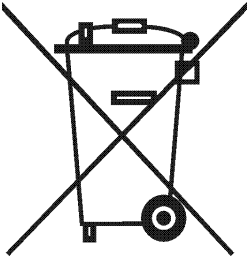

(Dutch)

Panasonic producten zijn ontwikkeld en gefabriceerd uit eerste kwaliteit materialen, de onderdelen kunnen worden gerecycled en weer worden gebruikt.

Het symbool betekent dat de elektrische en elektronische onderdelen wanneer deze vernietigd gaan worden, dit separaat gebeurt van het normale huisafval.

Zorg ervoor dat het verwijderen van de apparatuur bij de lokaal erkende instanties gaat gebeuren. In de Europese Unie wordt de gebruikte elektrische en elektronische apparatuur bij de daarvoor wettelijke instanties aangeboden.

Alstublieft help allen mee om het milieu te beschermen.

(Swedish)

Din Panasonic produkt är designad och tillverkad av material och komponenter med hög kvalitet som kan återvinnas och återanvändas.

Denna symbol betyder att elektriska och elektroniska produkter, efter slutanvändande, skall sorteras och lämnas separat från Ditt hushållsavfall.

Vänligen, lämna denna produkt hos Din lokala mottagningstation för avfall/återvinningsstation.

Inom den Europeiska Unionen finns det separata återvinningssystem för begagnade elektriska och elektroniska produkter.

Vänligen, hjälp oss att bevara miljön vi lever i!

LOW HUMIDITY MODE

The humidity in the chamber goes up over 90 %R.H. if the unit is running without low humidity mode when moisturized material is put inside the chamber. This may result in the condensation on the inside of the door or clearance in the chamber.

The low humidity mode is a running mode to reduce the condensation under above condition by running control with the set temperature between 20 °C and 40 °C

Refer to page 39 for the setting of low humidity mode.

※Default setting of the low humidity mode is 0 (No).

[When selecting the low humidity mode]

The compressor is on/off more than normal to reduce the condensation in the chamber. Accordingly, the fluctuation of the chamber humidity is more than the normal running mode.

The chamber humidity varies between 80 %R.H. and 50 %R.H. when the chamber temperature is set to 37 °C and the ambient temperature is 20 °C.

CAUTION

The material in the chamber may be dried depending on the usage condition when the low humidity mode is selected. Do not select the low humidity mode when the drying of culture media should be avoided.

[When selecting the normal mode (no low humidity mode)]

Pay attention to the following when the chamber temperature setting is lower than the ambient temperature with moisturized material put inside the chamber.

- The condensation may be found on the inside of the door or clearance in the chamber. Wipe off the condensation with a dry cloth.
- The condensation is held on the dew saucer and drained into the evaporating tray. The evaporating pipe is not heated when the compressor is off. Therefore, it is needed to clean the evaporating tray once a week.

※The amount of condensation depends on the usage condition.

CAUTION

Clean the evaporating tray regularly when selecting the normal mode (no low humidity mode). Spilled water from the evaporating tray causes the mold.

※With the normal mode, the drained water may be spilled from the evaporating tray when the condensation is found on the door. In this case, take out the drain pipe from the port and drain the water to a container or bucket.

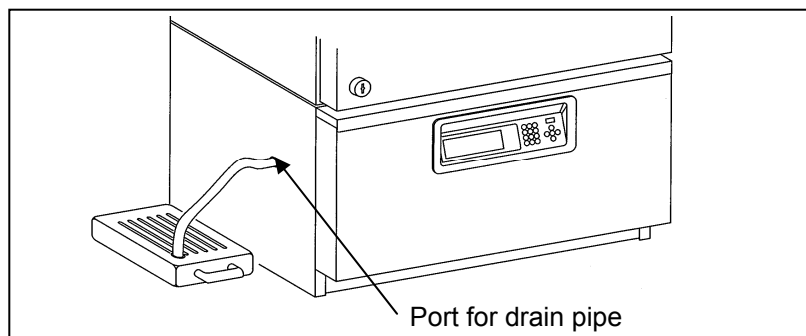

Consult our sales representative or agent when using the drain pipe.

PERFORMANCE DATA

Graph 1
Chamber temperature pull-down and pull-up characteristics

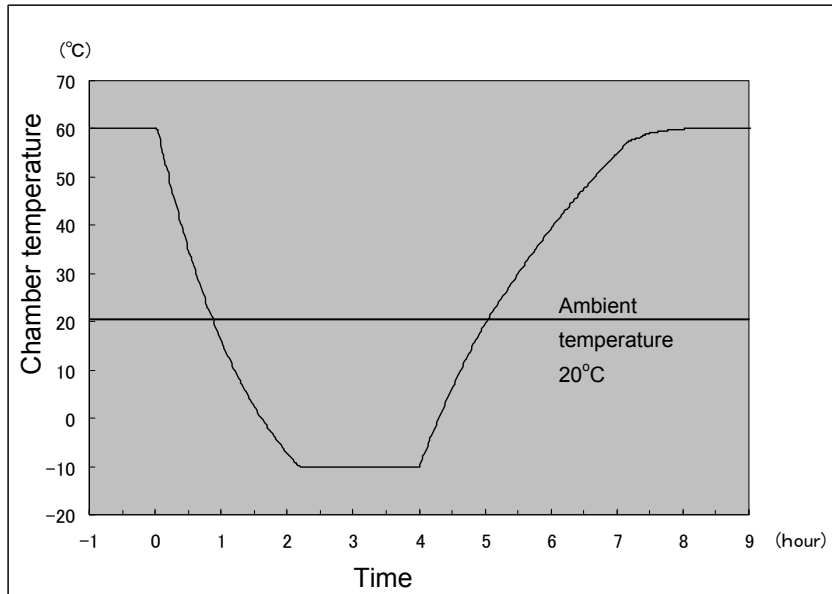

Graph 2
Relation between chamber heat load and attainable chamber temperature

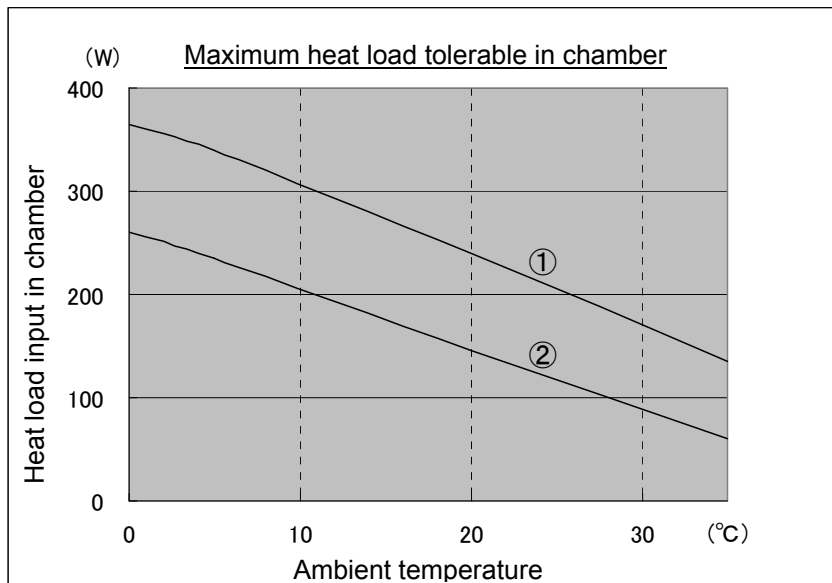

- ① Temperature reached, in chamber, 0°C
- ② Temperature reached, in chamber, -10°C

Note:

The performance data is the data with the lamp OFF.

The performance may be varied slightly depending on each unit or running condition.

SPECIFICATIONS

Product name	Cooled Incubator MIR-554
External dimensions	W800 mm x D832 mm x H1810 mm W31.50 inch x D32.76 inch x H71.26 inch
Internal dimensions	W640 mm x D550 mm x H1160 mm W25.20 inch x D21.65 inch x H45.67 inch
Effective capacity	406 L (14.33 cu.ft.)
Exterior	Painted steel
Interior	Stainless steel
Door	Painted steel
Shelf	Polyethylene coated steel wire, Adjustable, 5 shelves Inner dimensions : Upper 4 W580 mm x D440 mm (W22.83 inch x D17.32 inch) Bottom 1 W580 mm x D490 mm (W22.83 inch x D19.29 inch) Max. load : 50 kg (110.23 lb)
Access port	Inner diameter 40 mm (left and right side)
Insulation	Rigid polyurethane foamed-in place
Cooling method	Forced air circulation
Compressor	Reciprocated compressor Output; 250 W
Evaporator	Fin and tube type
Condenser	Wire and tube type
Refrigerant	R-404A
Defrost heater	322 W
Temperature controller	Microprocessor, PID control (compressor; ON-OFF)
Temperature display	Digital display
Alarm	High temp. alarm, Low temp. alarm, Independent over-heat/over-cool limiter
Remote alarm contact	Capacity; DC 30 V, 2 A
Program function	12 steps, 1 to 99 repeating or unlimited, Max. 10 programs memorized
Memory backup	Nonvolatile memory
Lamp	1 fluorescent lamp (FL15D) 15 W
Accessories	4 rubber caps for access port, 5 shelves, 20 clips, 1 set of key
Weight	195 kg (430 lb)
Optional components	Light add on kit (MIR-L15), Inner door (MIR-55ID) Interface board (MTR-480), Interface board (MTR-L03) Data acquisition system (MTR-5000)

Note: Refer to the updated catalog when ordering an optional component.

Designs and specifications are subject to change without notice.

PERFORMANCE

Product name	Cooled Incubator MIR-554		
Model No.	MIR-554-PA	MIR-554-PK	MIR-554-PE
Control range	-10 °C~+60 °C (ambient temp.: +5 °C~+35 °C, no load)*1*2		
Temperature fluctuation	±1.5 °C ON-OFF control (set: 5 °C, ambient temp: 20 °C, no load) ±0.2 °C PID control (set: 50 °C, ambient temp: 20 °C, no load)		
Temperature uniformity	±0.5 °C (set: 37 °C, ambient temp.: 20 °C, no load)		
Noise level	45 dB (A scale)		
Maximum pressure	2231 kPa		
Rated voltage	AC 110 V-115 V	AC 220V	AC 220 V-240 V
Rated frequency	60 Hz	60 Hz	50 Hz
Power consumption	290 W	295 W	285 W
Environmental conditions	Ambient temperature: +5 °C~+35 °C, Humidity: less than 80 %R.H.		

*1: The control range when the optional inner door (MIR-55ID) installed is -10 °C~+50 °C.

(Ambient temp.: +5 °C~+35 °C, no load)

*2: The lighting is available only with temperature range between +2 °C and +50 °C when the optional light add on kit (MIR-L15) is installed. In the case of temperature out of range, the lighting is not usable.

Note: The unit with CE mark complies with EC directives.

Each data of this product is measured by our standard.

All the described performances are applied for the rated supply voltage and the frequency.

Design or specifications will be subject to change without notice.

⚠ CAUTION

**Please fill in this form before servicing.
Hand over this form to the service engineer to keep for his and your safety.**

Safety check sheet

1. Incubator contents :

- Risk of infection: Yes No
Risk of toxicity: Yes No
Risk from radioactive sources: Yes No

(List all potentially hazardous materials that have been stored in this unit.)

Notes :

2. Contamination of the unit

Unit interior

- No contamination Yes No
Decontaminated Yes No
Contaminated Yes No

Others:

3. Instructions for safe repair/maintenance of the unit

- a) The unit is safe to work on Yes No
b) There is some danger (see below) Yes No

Procedure to be adhered to in order to reduce safety risk indicated in b) below.

Date :

Signature :

Address, Division :

Telephone :

Product name: Cooled Incubator	Model No. MIR-	Serial number:	Date of installation:
-----------------------------------	-------------------	----------------	-----------------------

Please decontaminate the unit yourself before calling the service engineer.

Panasonic Healthcare Co., Ltd.

1-1-1, Sakata Oizumi-Machi Ora-Gun, Gunma 370-0596, Japan

© Panasonic Healthcare Co., Ltd. 2012

Printed in Japan
7FB6P15155800
S0412-0