



KINEMATICA

Homogenizing perfected.

POLYTRON®



POLYTRON® SYSTEM PT 6100 D
Operating manual

**Garantie
Warranty
Upgrade**



Jetzt registrieren / Register now:
kinematica.ch/garantie-upgrade
kinematica.ch/warranty-upgrade

OPERATING MANUAL			
System	POLYTRON®		
Type	PT 6100 D		
Issue	3 / 01.07.2018		
Page	2	of	33

CONTENT:

1 INTRODUCTION	3
1.1 OPERATING INSTRUCTIONS.....	3
1.2 ORGANISATIONAL MATTERS	5
1.3 WARNING NOTICES.....	6
2 SAFETY.....	7
2.1 SUMMARY	7
2.2 SAFETY CONCEPT	7
2.3 RESIDUAL DANGERS.....	10
2.4 WARNINGS.....	11
3 DESCRIPTION OF THE EQUIPMENT.....	13
3.1 OVERVIEW	13
3.2 DRIVE UNIT.....	15
3.3 STANDS	18
3.4 POLYTRON® DISPERSING-AGGREGATES	19
3.5 TECHNICAL SPECIFICATIONS	20
4 INSTALLATION	21
4.1 UNPACK.....	21
4.2 ASSEMBLING OF THE DRIVE.....	21
4.3 ASSEMBLING OF THE STANDS	22
4.4 STARTING UP	22
5 MAINTENANCE	27
5.1 DRIVE	27
5.2 CLEANING AND MAINTENANCE OF THE AGGREGATES.....	28
6 TROUBLE SHOOTING	30
7 ACCESSORIES	31
8 WARRANTY	32
9 DISPOSAL.....	33

System	POLYTRON®		
Type	PT 6100 D		
Issue	3 / 01.07.2018		
Page	3	of	33

1 INTRODUCTION

This chapter gives information on the structure of this document. It will assist you in making use of it and show how to find the required information quickly.

1.1 OPERATING INSTRUCTIONS

PLEASE READ THESE OPERATING INSTRUCTIONS BEFORE SWITCHING ON OR OPERATING THE EQUIPMENT. THEY DESCRIBE THE USE OF THE POLYTRON® PT 6100 D, ITS INSTALLATION AND MAINTENANCE AND THE APPROPRIATE REPLACEMENT PARTS AND ACCESSORIES.

THEY WILL HELP YOU AVOID ERRONEOUS USE AND SUBSEQUENT DAMAGE. ALTHOUGH POLYTRON® UNITS ARE DESIGNED FOR EASE OF SERVICE, THIS DOES NOT RELEASE YOU FROM THE OBLIGATION TO INSPECT YOUR EQUIPMENT CAREFULLY AND TO CLEAN IT THOROUGHLY.

KINEMATICA AG is a specialist manufacturer of machines and equipment for dispersion and mixing technology.

An important objective of these operating instructions is to fully inform you, the user, about the correct and safe use of our equipment.

In order to achieve this, it is essential that you should carefully study chapter 2, "Safety", and follow the instructions in this book.

System	POLYTRON®		
Type	PT 6100 D		
Issue	3 / 01.07.2018		
Page	4	of	33

1.1.1 RANGE OF VALIDITY

The information in these operating instructions relates to the POLYTRON® identified as follows:

Manufacturer: KINEMATICA AG, CH-6014 Luzern
 Brand name: POLYTRON®
 Product name: POLYTRON® PT 6100 D

Order No.	Identification
11010110	Drive POLYTRON® PT 6100 D, 230 V, EU
11010111	Drive POLYTRON® PT 6100 D, 230 V, CH
11010112	Drive POLYTRON® PT 6100 D, 230 V, UK plug
11010113	Drive POLYTRON® PT 6100 D, 100-120 V, plug
11035001	Adapter for PT-DA / PTA aggregates
11040036	Stativ ST-P14/590+500 (230V, EU-plug)
11040033	Stativ ST-P14/590+500 (230V, CH-plug)
11040037	Stativ ST-P14/590+500 (230V, UK-plug)
11040034	Stativ ST-P14/590+500 (115V, US-plug)

OPERATING MANUAL			
System	POLYTRON®		
Type	PT 6100 D		
Issue	3 / 01.07.2018		
Page	5	of	33

1.1.2 TARGET AUDIENCE

These operating instructions are intended for all authorized users of our machines/equipment. We distinguish different user roles, taking account of the different demands placed on the user by the activity to be carried out.

You will find the definitions of user roles with the demands on the user in chapter 2, "Safety". You can fulfill one or more of these roles, provided that you meet the corresponding demands.

1.2 ORGANISATIONAL MATTERS

If you are unable to find the answer to any question in the operating instructions, please contact the equipment manufacturer directly.

1.2.1 LOCATION OF THE OPERATING INSTRUCTIONS

The operating instructions can only be of use to you if you always have them at hand. They should therefore always be kept at the place where the equipment is used.

1.2.2 MANUFACTURER CONTACT ADDRESS

KINEMATICA AG

Luzernerstrasse 147a
CH-6014 Luzern
Switzerland

Tel.: +41-41-259 65 65
Fax: +41-41-259 65 75
e-mail: info@kinematica.ch

System	POLYTRON®		
Type	PT 6100 D		
Issue	3 / 01.07.2018		
Page	6	of	33

1.3 WARNING NOTICES

Please be aware of the meaning of the following warning signs:



SAFETY INSTRUCTIONS MUST BE OBSERVED TO ENSURE SAFE OPERATION.



THIS SYMBOL INDICATES HIGH VOLTAGE, WITH RISK TO HEALTH AND ENVIRONMENT.



**CAUTION!
BEWARE OF HOT SURFACE.**



**CAUTION!
DEVICE NOT DESIGNED FOR USE IN EXPLOSION DANGER ENVIRONMENT.**

OPERATING MANUAL			
System	POLYTRON®		
Type	PT 6100 D		
Issue	3 / 01.07.2018		
Page	7	of	33

2 SAFETY

This chapter is directed at all users of KINEMATICA laboratory equipment. It includes information on safe and optimum use.

2.1 SUMMARY

Any incorrect use of the installed equipment can be dangerous. Inadequately trained users can cause material damage and personal injury. This chapter informs you about the safety concept and the requirements for safe and optimum use of the equipment.

All those authorized to operate, service and repair the equipment are required to study chapter 2, "Safety".

2.2 SAFETY CONCEPT

The safety concept sets down the entitlement to use the equipment and the responsibilities of the individual users.

The machines and equipment are designed and constructed according to the state of the art and the recognized safety rules.

2.2.1 INTENDED USE OF THE EQUIPMENT

The equipment is designed and constructed for the following use:

- Dispersion and homogenization of pumpable fluid products in accordance with the technical specifications (see point 3.5) and compatibility with the materials coming into contact with the products.

If you use the equipment for any purpose other than those listed, the manufacturer cannot be held liable for any resulting damage.

2.2.2 IMPROPER USE

Any use other than the "intended use" without the written approval of the manufacturer or any operation outside the technical limits of use is improper use.

OPERATING MANUAL			
System	POLYTRON®		
Type	PT 6100 D		
Issue	3 / 01.07.2018		
Page	8	of	33

2.2.3 USER ROLES

To guarantee safety, we place requirements on the users of the equipment that must be met without fail. Only persons meeting the requirements are authorized to work with the equipment.

We describe all those who work with the equipment as users. Since the requirements of these users are very much dependent on their activity, we distinguish the following user roles.

Contract partner:

The manufacturer can impose legal obligations on the contract partner when the equipment is purchased. The contract partner is obliged to ensure that the equipment is properly used.

Operating company:

The operating company ensures that the equipment is properly used and authorizes persons who are entitled to work with the equipment in any one of the defined user roles. They are under the obligation to instruct the users.

Note:

Contract partner and operating company can be the same person.

Service technician:

The service technician is an employee of the operating company and looks after the equipment in special operating mode(s). He is a specialist with mechanical, electrical and electronic professional training. The service technician undertakes commissioning, decommissioning service and repair of the equipment. He must be appropriately trained to be able to carry out the service work required.

Operator:

The operator turns the equipment on and off. In the event of an alarm signal he informs the service technician.

OPERATING MANUAL			
System	POLYTRON®		
Type	PT 6100 D		
Issue	3 / 01.07.2018		
Page	9	of	33

2.2.4 DANGER AREA

System/equipment

The system danger area includes the whole system/equipment including the connecting lead and controls.

Proximity danger area

This refers to all areas within a defined distance of the equipment.

User danger area

This danger area includes all persons working with the equipment.

2.2.5 AREAS OF RESPONSIBILITY

In order that the system/equipment can be used safely and without risk, the users in various roles bear the responsibility for particular danger areas.

Contract partner:

The contract partner bears the responsibility for the "proximity danger area".

Operating company:

The operating company bears the responsibility for the "user danger area". Only those users may be authorized to operate the system/equipment who fulfill all requirements of the user roles concerned. In doing so, attention must be paid to the following points:

- It is to be ensured that all users of the system/equipment have fully read and understood chapter 2, "Safety" and act accordingly in a safety-conscious manner.
- It is to be ensured that no unauthorized person carries out work with the system/equipment.
- It is to be ensured that users are informed of the possible risks and dangers connected with the system/equipment.
- It is to be ensured that those being trained or engaged in general training are under the permanent supervision of a trained and authorized person.

OPERATING MANUAL			
System	POLYTRON®		
Type	PT 6100 D		
Issue	3 / 01.07.2018		
Page	10	of	33

Service technician:

The service technician bears the responsibility for the "system/equipment danger area". He ensures that the system/equipment is at all times free from technical faults, safe and functions correctly.



2.2.6 GENERAL SAFETY RULES

Observe the following general safety rules:

- follow these operating instructions,
- in addition, observe the legal obligations and requirements for accident prevention and environmental protection of the country in which you operate the equipment,
- do not make any modifications to the equipment without the written authorization of the manufacturer,
- only original replacement parts may be used for repairs,
- before any service work on the equipment, it must be ensured that the electrical supply is switched off,
- after any service, maintenance or repair work has been carried out on the system/equipment, it must be given a test run by the service technician.
- depending on the place at which it is installed, circumstances may require that hearing protection is worn when remaining in the vicinity of the equipment for long periods.

2.3 RESIDUAL DANGERS

When the system/equipment is used in accordance with rules and regulations, residual dangers are minimal.





Residual danger	Countermeasures
Tripping over feed or return lines	These should be laid appropriately.
Breakage of glass containers Spitting of the product	Wear protective clothing (goggles etc.).  
Hearing loss due to loud noise.	According to the application ear protection must be used. 
Tilting of the device	Use stable, non-slip base and the safety stands from KINEMATICA

System	POLYTRON®		
Type	PT 6100 D		
Issue	3 / 01.07.2018		
Page	11	of	33







IN EVERY CASE THE ELECTRICAL INSTALLATION HAS TO BE DONE BY TECHNICIAN!

2.4 WARNINGS

	<ul style="list-style-type: none"> • Ensure that the rated voltage of the equipment matches the supply. • Before changing any dispersing aggregate, the line cord has to be plugged out • When a electrical power blackout occurs, the device has to be switched- off using the main switch, avoiding the device to restart automatically. • IT IS IMPORTANT THAT THE MAINS SUPPLY WHERE THE DEVICE IS PLUGGED IN COMPLIES WITH THE INFORMATION ON THE TYPE LABEL AND THE INTERNATIONAL STANDARDS FOR POWER SUPPLIES. IF NOT, SUCCESSFUL OPERATION CANNOT BE GUARANTEED
	<ul style="list-style-type: none"> • In the event that hazardous chemicals or materials that endanger health can influence the surroundings or use of the equipment, appropriate countermeasures must be taken.
	<ul style="list-style-type: none"> • At long term use the aggregate and the coupling may get hot - danger of skin burn.
	<ul style="list-style-type: none"> • The equipment may not be operated in explosive areas • It is not allowed to work with fluids which are highly inflammable. • It is not allowed to mix materials which can cause strong exothermal reactions

WARNINGS: continued

System	POLYTRON®		
Type	PT 6100 D		
Issue	3 / 01.07.2018		
Page	12	of	33

	<ul style="list-style-type: none"> • THE DEVICE MAY ONLY BE OPENED BY AUTHORISED KINEMATICA SERVICE STATIONS. • Ensure that enough free space is available at the backside of device, so that effective air flow and cooling is assured. Insufficient cooling may lead to a decrease of power output. • The device has to be placed in a manner that dirt or fluids cannot penetrate through the ventilation slots at back side of the drive. • POLYTRON® dispersion aggregates may not be operated dry – the lower sleeve bearing is cooled and lubricated by the medium being processed. Running dry will destroy the sleeve bearing. • The dispersing aggregates should be cleaned after every operation. • Never pull the coupling during operation – the aggregate could fall out of the coupling.
	<ul style="list-style-type: none"> • <u>NOTE:</u> With a standard aggregate length of 250mm speeds up to 26'500rpm are possible. If longer aggregates as 250mm are used the max. speed is limited. For example, as with an aggregate length of 400mm the max. speed allowed is 12'000rpm.
	<ul style="list-style-type: none"> • When the line cord is plugged, never touch the saw teeth of the aggregate – danger of injuries due to rotating shafts and blades
	<p>KINEMATICA AG products comply with all the usual CE directives, carry the CE marking and are delivered with a corresponding declaration of conformity.</p>

OPERATING MANUAL			
System	POLYTRON®		
Type	PT 6100 D		
Issue	3 / 01.07.2018		
Page	13	of	33

3 DESCRIPTION OF THE EQUIPMENT

The PT 6100 D system conforms to all current and relevant CE regulations, carries the CE sign and is supplied with the relevant certificate of conformity.

3.1 OVERVIEW

The POLYTRON® System PT 6100 D prepares the finest dispersions and homogenizations and is suitable for use with working volumes up to 20'000 ml (depending on the viscosity of the product and the dispersing aggregate used). The drive can be equipped with a wide range of POLYTRON® dispersing-aggregates. The aggregates are easy to change using the quick-coupling.

Using the adapter (optional, order no.: 11095000), PTA-aggregates (from former models PT-K / PT10-35/ PT-G / PT 45-80) can also be equipped.

For a ready-to-use system you need:

- **Drive PT-MR 6100 D**
- **A stand**
- **A dispersing aggregate**
- **A mains connection according to the type label**

On the following pages pictures and a description of the main components of the complete system PT 6100 D can be found.



KINEMATICA

Homogenizing perfected.

OPERATING MANUAL

System	POLYTRON®		
Type	PT 6100 D		
Issue	3 / 01.07.2018		
Page	14	of	33



System	POLYTRON®		
Type	PT 6100 D		
Issue	3 / 01.07.2018		
Page	15	of	33

3.2 DRIVE UNIT

The drive unit PT 6100 D is equipped with a 1'700 W motor and will be started using the main switch placed at the front side. Within the speed range of up to 26'500 rpm, the integrated closed loop speed control will tune the speed to any adjusted value, independent from load changes.

Target speed, actual speed (set speed) and several other parameters are indicated on the two-line-display.

Using the provided control software with the connection cable to PC the unit can be operated by remote control. At the back side the unit is also equipped with connection for pt100 temperature-probe. The measured temperature can be viewed on the display. Furthermore the electronic control system is equipped with safety functions with automatic shut down to prevent the drive being overheated or blocked. A detailed description of possible errors and counter measurements is listed in chapter 6 „TROUBLE SHOOTING“

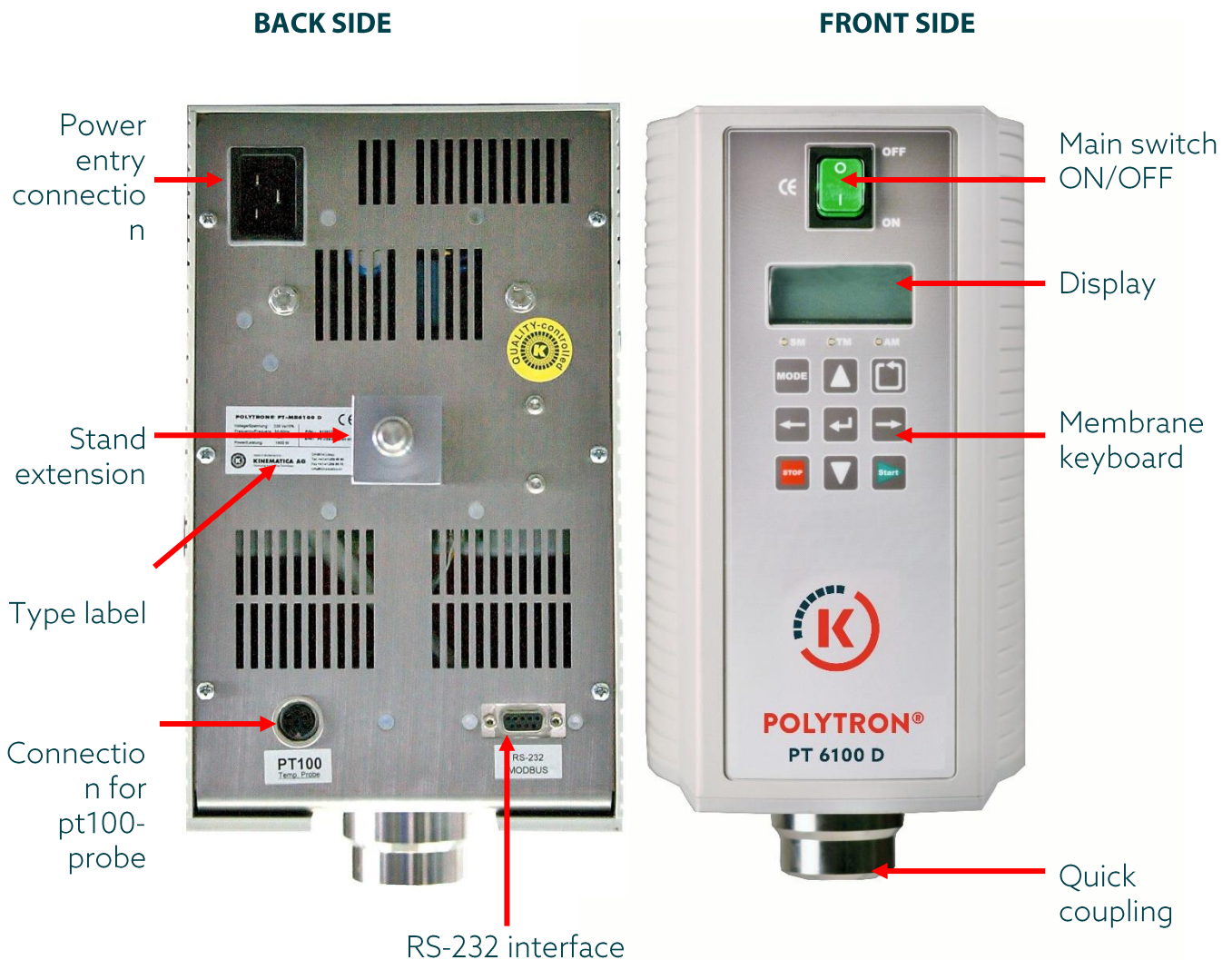

System	POLYTRON®		
Type	PT 6100 D		
Issue	3 / 01.07.2018		
Page	16	of	33

3.2.1 OPERATION & CONTROL

The POLYTRON® PT 6100 D can be operated using the membrane keyboard. All operating parameter can be viewed on the 2-line-display. The unit can be operated in 3 different modes:





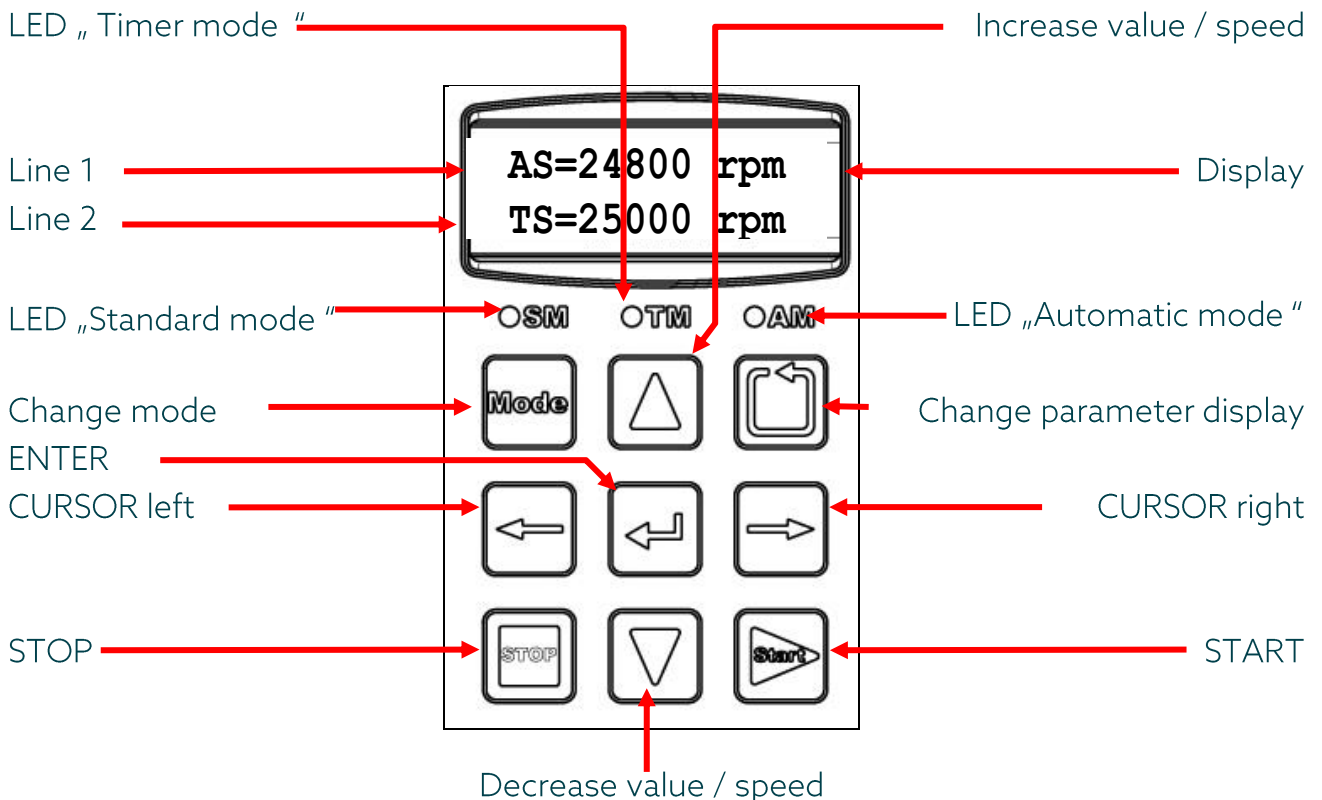





- Standard mode : This mode for manual usage of the unit using the membrane keyboard.
- Timer mode : This mode is for programming a time-speed sequence where the drive runs at certain constant speed for a certain time. After having finished the countdown the drive stops automatically
- Automatic mode : (Remote control) Using the provided control software with the connection cable to PC the unit can be operated by remote control.

See description of the elements of the membrane keyboards below



System	POLYTRON®		
Type	PT 6100 D		
Issue	3 / 01.07.2018		
Page	17	of	33

See description of the elements of the membrane keyboards below

Button / Indication		Description
	LED „Standard mode “	Indicates when „Standard mode“ is active
	LED „Timer mode “	Indicates when „Timer mode“ is active
	LED „Automatic mode “	Indicates when „Automatic mode “is active (cannot be chosen manually, will be activated only when unit is connected to PC.)
	Change mode	To change between “Standard & Timer mode”
	ENTER	To confirm entries
	CURSOR left / right	Changes cursor positions
	Increase / decrease value / speed	Timer mode : Increase / decrease value / speed when entering speed & time
		Standard mode: Increase / decrease speed
	START	By pushing this button, the speed controller starts working to run the drive to the target speed
	STOP	By pushing this button the motor will be stopped instantly. Value of target speeds will be saved
	Change viewed Parameter	By pushing this button, process parameters will be displayed sequentially in line 2 of the display

System	POLYTRON®		
Type	PT 6100 D		
Issue	3 / 01.07.2018		
Page	18	of	33

3.3 STANDS

The drive is designed to be operated at stands. KINEMATICA recommends the following stand for safe usage of the drive. The usage of a vessel holder is also recommended.

ST-P14/590+500



System	POLYTRON®		
Type	PT 6100 D		
Issue	3 / 01.07.2018		
Page	19	of	33

3.4 POLYTRON® DISPERSING-AGGREGATES

A wide range of dispersing aggregates with diameters of 5, 7, 12, 20, 30, 36, 40, 50 and 60 mm are available. For questions concerning POLYTRON® dispersing aggregates please get in contact with KINEMATICA or your local specialist dealer.

Due to the quick coupling, POLYTRON® dispersing aggregates can be fitted and replaced very easily. The three pictures below show the mounting of an aggregate.

For easy mounting, the crown head of the aggregate and the coupling should be free of dirt.

Push the slider of the coupling upwards, at the same time push aggregate into the coupling.

Push the aggregate upwards and at same time twist it a little until it has snapped in and the slider returns downwards

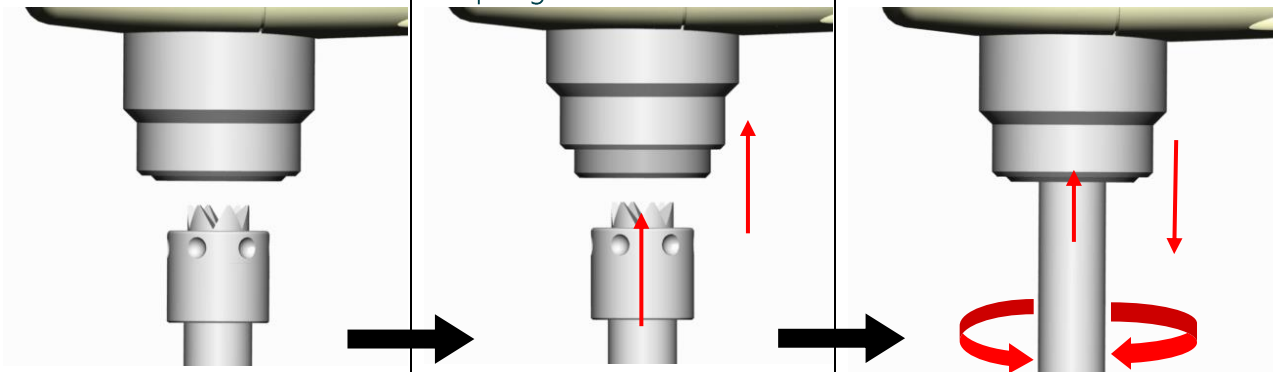

To remove the aggregate, proceed in reverse direction.



CAUTION!:

BEFORE PUSHING UP THE SLIDER OF THE COUPLING, HOLD YOUR DISPERSING AGGREGATE IN ONE HAND AVOIDING THE AGGREGATE TO FALL DOWN WHEN PUSHING UP THE SLIDER.

System	POLYTRON®		
Type	PT 6100 D		
Issue	3 / 01.07.2018		
Page	20	of	33



CAUTION!
WHEN REPLACING AN AGGREGATE THE LINE CORD HAS TO BE DISCONNECTED FROM THE POWER SUPPLY

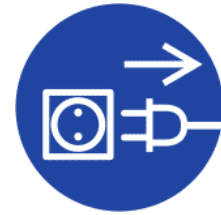

CAUTION!
AT LONGTERM USE AT HIGH LOADS, THE AGGREGATE & THE COUPLING CAN HEAT UP TO HIGH TEMPERATURE LEVELS - DANGER OF SKIN BURN.



3.5 TECHNICAL SPECIFICATIONS

Drive PT-MR 6100 D			
motor type	universal motor		
supply voltage	210-250 V	115 V	100 V
supply frequency	50/60 Hz		
Max. current	approx. 8 A	approx. 16 A	
Max. speed	Up to 26'500 min ⁻¹		23'000 min ⁻¹
Max. input power	approx. 1700 W		
Max. output power	approx. 1250 W		
soft-start	yes		
noise emission (drive only)	Approx. 82 dB(A) at 26'500 rpm		
direction of rotation	clockwise, seen from above		
ambient temperature	0 - 40°C		
relative humidity	95% max.		
certified standards	EMC : IEC/EN 61000-6-2 / EN 61000-6-3		
	Safety: IEC/EN 61010-2-51		
protection type	IP 20		
Max. period of continuous operation	Depending on load & speed 100 % duty time is possible.		
dimensions	See appendix		
weight	7.4 kg (drive only)		



NOTE: With a standard aggregate length of 250mm speeds up to 26'500rpm are possible. If longer aggregates as 250mm are used the max. speed is limited. For example, as with an aggregate length of 400mm the max. speed allowed is 12'000rpm.

System	POLYTRON®		
Type	PT 6100 D		
Issue	3 / 01.07.2018		
Page	21	of	33

4 INSTALLATION

4.1 UNPACK

Open the dispatch box and check that the contents agrees with the delivery note.



CHECK ALL PARTS FOR POSSIBLE TRANSPORT DAMAGE. INFORM US OR YOUR DEALER IMMEDIATELY ABOUT ANY DISAGREEMENT OR FAULT. If possible SEND US DIGITAL PHOTOS BY EMAIL TO INFO@KINEMATICA.CH

4.2 ASSEMBLING OF THE DRIVE

The drive PT-MR 6100 D arrives fully equipped.
Only the power cable has to plugged in the power inlet



System	POLYTRON®		
Type	PT 6100 D		
Issue	3 / 01.07.2018		
Page	22	of	33

4.3 ASSEMBLING OF THE STANDS



CAUTION!
WHEN USING STAND FROM OTHER SUPPLIERS, ASSURE NOT TO USE STANDS WHICH COULD BE TILT OUT. THIS COULD LEAD TO TILT OVER OF THE WHOLE SYSTEM.

Please find attached to your ordered stand a detailed assembly instruction



Verkaufsnummer Order-No.	Bezeichnung Description
11040036	ST-P 14/590+500 CH
11040033	ST-P 14/590+500 EU
11040037	ST-P 14/590+500 UK
11040034	ST-P 14/590+500 100-120 V

Plattenstativ mit Teleskop-Hubsäule und Gefäßhalter
Plate stand with telescopic lifting column and receptacle holder



1. Hubsäule A senkrecht auf einer ebenen Fläche auf die Kopfplatte stellen.
1. Put lifting column A on a flat surface vertically onto the head plate.



2. Bodenplatte B bündig auf die Unterseite der Hubsäule legen und ausbalancieren. **ACHTUNG: KIPPGEFAHR!**
2. Put base-plate B flush onto the bottom of the column and balance it out. **CAUTION RISK OF TIPPING!**

Zusammenstellung / Lieferumfang / Werkzeuge:
A: Hubsäule, B: Bodenplatte, C: Controlbox, D: Bedienelement mit Aktivierungsstecker, E: Motorkabel, F: Sockel für das Bedienelement, passendes Netzsteckel (CE/UK/US (nicht abgebildet), W1: 8mm Gabelschlüssel, W2: 10mm Gabelschlüssel, W3: 3mm Inbusschlüssel, A1: 4x ekt. Schraube, A2: 4x ekt. Schraube Mx25, A3: 1x Gewindestift Mx10, A4: 2x Senkschraube Mx14.

Assembly / scope of delivery / tools:
A: Lifting column, B: Base-plate, C: Control box, D: Operating element with activation plug, E: Motor cable, F: Base for the operating element, suitable cables CH / EU / UK / US (not shown), W1: 8mm spanner, W2: 10mm spanner, W3: 3mm Allen key, A1: 4x 6 hex bolt, A2: 4x 6 hex bolt Mx25, A3: 1x set screw Mx10, A4: 2x Mx14 countersunk screw.



3. Schrauben A2 zuerst von Hand anschrauben, danach richtig festziehen (10mm Gabelschlüssel W2).
3. Tighten A2 screws by hand first, then tighten properly (10mm spanner W2).



4. Stativ wieder senkrecht auf die Platte stellen. Die unteren Schrauben an den Führungssäulen lösen und die kleine Platte abnehmen (10mm Gabelschlüssel W2).
4. Place stand again vertically onto the base-plate. Undo the lower screws on the guide columns and remove the small plate (10mm spanner W2).

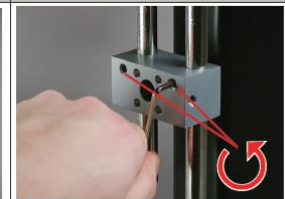

5. Zwei Gewindestifte an der Kreuzmuffa lockern (3mm Inbusschlüssel W3).
5. Loosen the two set screws on the boss head (3mm Allen key, W3).



Luzernerstrasse 147a
8014 Luzern
Schweiz
Tel. +41-41-259 65 65
Fax +41-41-259 65 75
e-Mail info@kinematika.ch



4.4 STARTING UP

System	POLYTRON®		
Type	PT 6100 D		
Issue	3 / 01.07.2018		
Page	23	of	33

- Ensure that the voltage marked on the type label complies with your power supply.
- Mount a dispersing aggregate into the coupling
- Plug in the mains cable to your power supply.
- Turn the drive on using the main switch.
- Immerse the aggregate in the product. The optimum depth of immersion of the dispersion attachment is about 70 % of the total depth of product in the container. Never immerse the upper coupling head and upper hole of the dispersion aggregate.
- Turn on at the main switch.

Remark:

In some cases it can be advantageous to place the vessel excentric in order to get more turbulences for better mixing of the product.



POLYTRON® DISPERSING AGGREGATES MAY NOT BE OPERATED DRY - THE LOWER SLEEVE BEARING IS COOLED AND LUBRICATED BY THE MEDIUM BEING PROCESSED. RUNNING DRY WILL DESTROY THE SLEEVE BEARING.

THE DISPERSING AGGREGATES SHOULD BE CLEANED AFTER EVERY OPERATION.





NEVER TOUCH THE ROTATING AGGREGATE - DANGER OF SEVERE CUT-INJURIES.



NOTE: With a standard aggregate length of 250mm speeds up to 26'500rpm are possible. If longer aggregates as 250mm are used the max. speed is limited. For example, as with an aggregate length of 400mm the max. speed allowed is 12'000rpm.

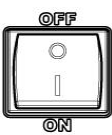





System	POLYTRON®		
Type	PT 6100 D		
Issue	3 / 01.07.2018		
Page	24	of	33

4.4.1 OPERATION IN STANDARD MODE

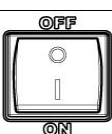
Turn the driven on using:		main switch
Adjust speed using:	 	increase / decrease buttons
To start up, press START:		motor will start rotating
The speed can be adjusted during operation using Increase / decrease		
To stop, press STOP:		motor will stop, Target speed value will be saved.

4.4.2 OPERATION IN TIMER MODE

Timer mode is useful to complete recurring tasks which are running at a given constant speed for certain time period

Turn the driven on using:		main switch
Press MODE		TIMER mode will be activated. The LED TM will be illuminated
Press ENTER		On the display the message „Enter Time“ occurs
Enter value for „time“ using „increase / decrease“- and „cursor“ buttons. Confirm entry by pressing ENTER		increase / decrease value
		Change digit
Enter value for „time“ using „increase / decrease“- and „cursor“ buttons. Confirm entry by pressing ENTER		After having entered the „time“, the message „Enter Speed“ occurs.
		The sequence is now programmed and can be executed.

System	POLYTRON®		
Type	PT 6100 D		
Issue	3 / 01.07.2018		
Page	25	of	33

To execute the sequence press START



The drive will start the timer countdown and will at the programmed speed during the programmed time period and will stop automatically w

The countdown sequence can be paused by pressing STOP.



The message „Paused“ occurs:

- By pressing START the sequence can be continued again.
- When pressing STOP again the sequence will be fully stopped.

When the TIMER sequence is finished the unit will start beeping and the message “Finished” occurs on the display.

By pressing STOP the beeping can be stopped



The timer is no reset to the values which have been entered first.

By pressing START the same sequence be executed again.



REMARK:

The internal clock where the timer mode operation is based on works with an accuracy of +/- 3 % of the entered time value. That means that a programmed sequence of for example 100 seconds runs with accuracy of +/- 3 seconds.

4.4.3 OPERATION IN AUTOMATIC MODE USING RS232 INTERFACE

See separate documentation „User Interface PT 6100 D“

OPERATING MANUAL			
System	POLYTRON®		
Type	PT 6100 D		
Issue	3 / 01.07.2018		
Page	26	of	33

4.4.4 VIEWING PROCESS PARAMETERS

By pressing the  - button the following process parameters can be viewed on line 2 of the display sequentially.

REMARK:

The PT-MR 6100 D is not a specially designed measuring device. Therefore a special calibration procedure is not needed for operating. For the values of the process parameters indicated on the display the accuracies stated in the following table are valid. If for any application there may be needed more accurate values of parameters such as product temperature, there has to be applied specially designed measuring devices

PARAMETER	DESCRIPTION	UNIT	ACCURACY	Full Scale
AS	Actual speed	rpm	+/- 1.0 % FS	0..30'000
Pin	Input power from mains supply	Watt	+/- 15.0 % FS	0..2'000
Pout	Trend indication for Power at motor shaft	Watt	+/- 7.0 % FS	0..2'000
M	Trend indication for Torque at motor shaft	Ncm	+/- 6.0 % FS	0..60
I	Motor current	Ampère	+/- 3.0 % FS	0..14
U	Voltage level of power supply	Volt	+/- 1.0 % FS	0..253
Tp	Product temperature, measured using the optional pt100 probe	°C	+/- 1.5 % FS	0..200
Tc	Temperature of internal speed controller	°C	+/- 1.5 % FS	0..200
Oh	Operating hours: cumulated hours during drive was turned on	Hours	+/- 1 h	0..65'000
Vx.xx	Version of the internal firmware release	-	-	-

System	POLYTRON®		
Type	PT 6100 D		
Issue	3 / 01.07.2018		
Page	27	of	33

5 MAINTENANCE

Your POLYTRON® unit is designed for easy servicing. Nevertheless, it is essential to inspect your equipment carefully and to clean it thoroughly. Drawings of the separate components are to be found in the appendix.



THE EQUIPMENT MUST BE DIS-CONNECTED FROM THE ELECTRICAL SUPPLY:

- **DURING ANY WORK ON THE EQUIPMENT, IN ORDER TO AVOID ANY PERSONAL INJURY OR OTHER DAMAGE**
- **WHEN CHANGING OR REMOVING THE DISPERSING AGGREGATE**

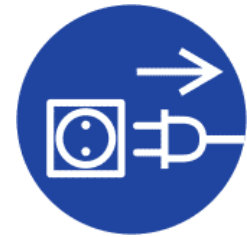

5.1 DRIVE

Under normal working conditions, the PT 6100 D drive requires no servicing. Parts such as the motor brushes and bearings are subject to natural wear.

The following are standard values for wear parts of the drive:

- bearing: several 1000's of operating hours.
- brushes: Approx. 150 hours of operating at rated power.

We strongly recommend that service work and repairs should be carried out only by authorized KINEMATICA service centres or by KINEMATICA directly, where original replacement parts are available.

For cleaning the housing and any other outside surface please assure that the cleaning agent is in compliance with the following materials:

- Polyamide (housing and membrane keyboard)
- Stainless steel 304 / 316 L
- Aluminium

Any unauthorised modification or manipulation of the unit or its equipment leads to immediate annulment of the warranty.

System	POLYTRON®		
Type	PT 6100 D		
Issue	3 / 01.07.2018		
Page	28	of	33

5.2 CLEANING AND MAINTENANCE OF THE AGGREGATES

EC-aggregates, (EC stands for EASY CLEAN) are easy to disassemble and clean. With some restrictions(*) they can be sterilised in an autoclave by several methods. In the following three chapters the de/assembling procedures will be described.

(*) Depending on the frequency and the intensity of the sterilisation process, the life span of the bearings may be reduced due to loss of grease during evacuation in a autoclave.



CAUTION!
BE AWARE OF SHARP EDGES AND TEETH WHEN DE/ASSEMBLING AGGREGATES – DANGER OF CUT-INJURIES

5.2.1 Dis/assembling of EC-aggregates with size Ø5 and Ø7 mm

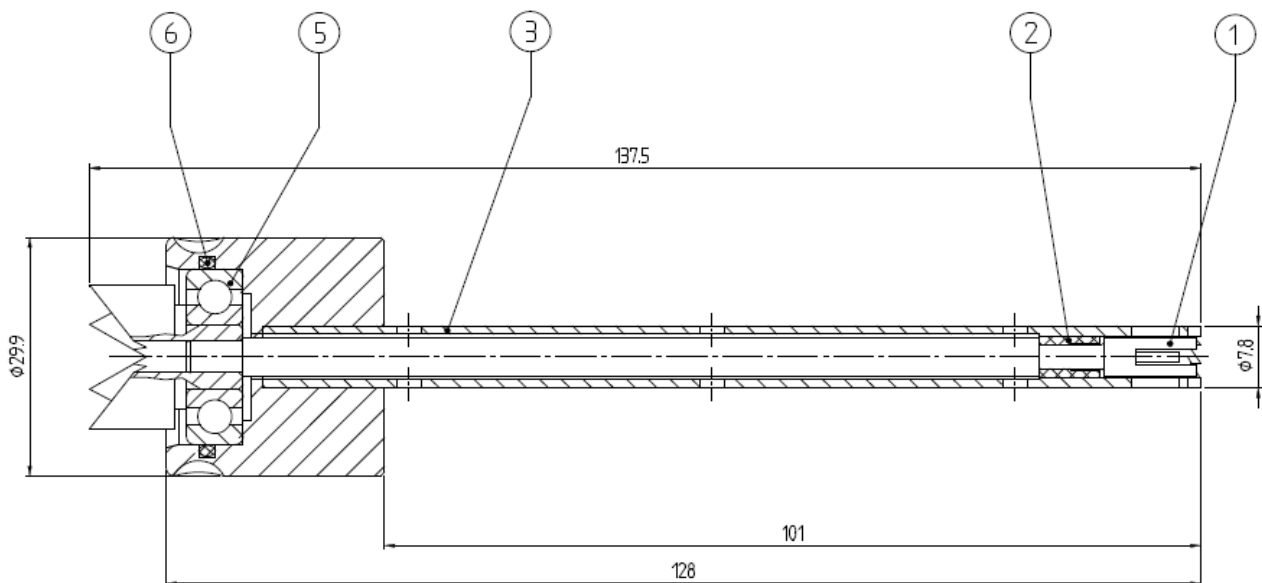

1. Push the shaft (1) from the right side out of the stator pipe.
2. Remove the slide bearing(2) from the shaft.
3. Remove the o-ring(6).
4. After the cleaning process, reassemble the aggregate in reverse order.

System	POLYTRON®		
Type	PT 6100 D		
Issue	3 / 01.07.2018		
Page	29	of	33

5.2.2 Dis/assembling of EC-aggregates with size $\varnothing 12$ und $\varnothing 20$ mm

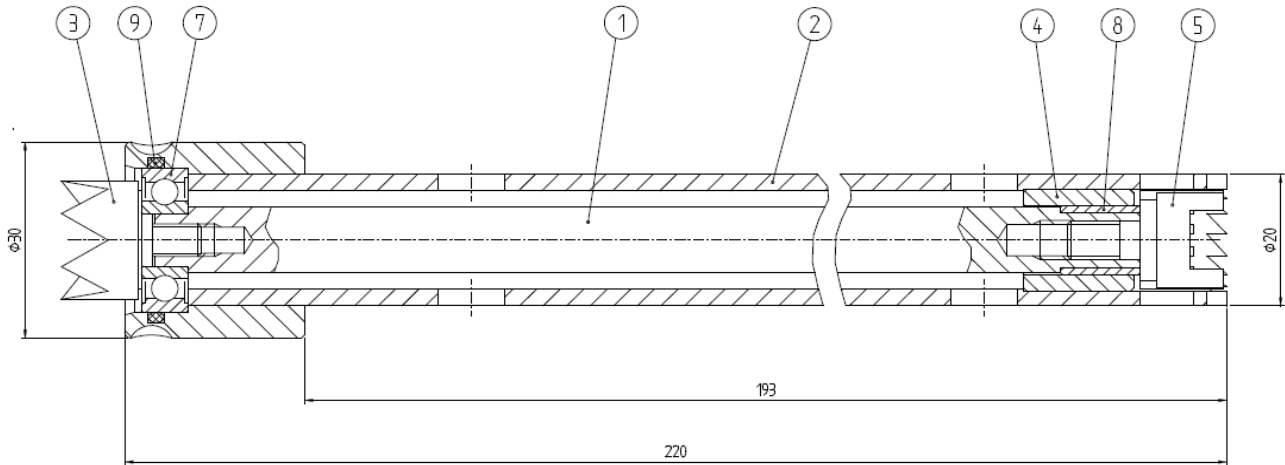

1. Fix the crown head(3) using the tool. Unscrew the rotor (5) using a suitable tool. Pull out the shaft(1)of the stator tube.
2. Remove the o-ring(9) out of the groove.
3. Unscrew the crown head from the shaft.
4. After the cleaning process, reassemble the aggregate in reverse order.

5.2.3 Dis/assembling of EC-aggregates with size $\varnothing 30+$

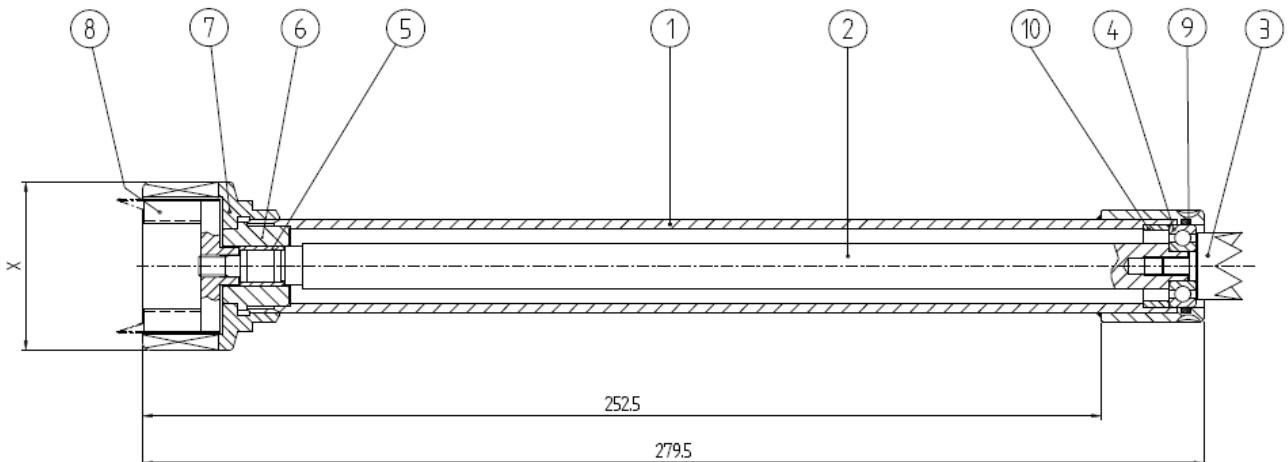

1. Fix the crown head (3) using the tool. Unscrew the rotor (8) using a suitable tool. Pull out the shaft (2) of the stator tube.
2. Unscrew the stator(7).
3. Pull out the shaft (2) of the stator tube(1).
4. Remove the o-ring (9) out of the groove.
5. Unscrew the crown head(3).
6. After the cleaning process, reassemble the aggregate in reverse order.

OPERATING MANUAL			
System	POLYTRON®		
Type	PT 6100 D		
Issue	3 / 01.07.2018		
Page	30	of	33

5.2.4 Criteria for replacement of the ball bearings

Basically, it is the operating company that determines when and how often the bearings are to be changed. They should, however, be changed at the latest if:

- rotor and stator are touching
- there is an increase in vibration,
- the rotor projects above the edge of the stator.

For a replacement of the ball bearings please contact a certified KINEMATICA service center or KINEMATICA directly.

Any unauthorized modification or manipulation of the unit or its equipment leads to immediate annulment of the warranty.

6 TROUBLE SHOOTING

PROBLEM	REASON	CORRECTIVE MEASURES
Unusual noises	Damaged drive bearings	Change ball bearings. Trace & replace defective parts (shaft, bearings)
	Damaged aggregate bearings	Change bearings
	Rotor/stator interference	Trace and replace defective parts (shaft, bearings)
Drive automatically stops & an alternating beeping sound is audible	Inadequate ventilation	Check if ventilation slots are clear. Cool down the device & restart
	Thermal overload	Check manner of use. Cool down the device & restart.
Drive does not start and message "under-/over voltage" occurs"	Mains supply does not provide exact voltage	Check your mains supply
Vibrations	Bent shaft	Replace shaft
	Worn bearing(s)	Replace bearing(s)
	Defective coupling	Trace and replace defective parts
Drive does not start respectively suddenly stops. A constant beeping sound is audible.	Defective internal control	Send the equipment to the nearest authorized KINEMATICA service centre or directly to KINEMATICA AG
	Drive is blocked	Check the aggregate for solid particles which may be blocking the rotor, remove the particles, turn off the drive and restart operation.

System	POLYTRON®		
Type	PT 6100 D		
Issue	3 / 01.07.2018		
Page	31	of	33

7 ACCESSORIES

A large selection of special homogenizing vessels is available, which can improve the efficiency of the processing of your product. Closed vessels to withstand vacuum or pressure can also be supplied.

Ask your dealer or contact KINEMATICA AG directly.

	pt100 probe	Order-No.	Lengths
	For measuring the product temperature. The probe can be plugged into connection on the back side of the drive	11020050	Approx. 2 m

System	POLYTRON®		
Type	PT 6100 D		
Issue	3 / 01.07.2018		
Page	32	of	33

8 WARRANTY

KINEMATICA AG guarantees that the equipment that it produces will run free of any fault related to materials or manufacturing faults for 24 months.

ADDITIONAL WARRANTY FOLLOWING REGISTRATION

Consumers who complete a warranty registration within 20 days of receiving their device will benefit from a free warranty extension of a further 12 months. This means that the total warranty period after registration is 36 months.

REGISTER NOW



kinematica.ch/warranty-upgrade

If thorough testing shows a fault to be due to either of the above causes, KINEMATICA AG guarantees that the equipment will be repaired or replaced free of charge. The guarantee does not cover parts that are subject to normal wear. It is void if any person other than an employee of KINEMATICA AG or their appointed representative has made modifications to the equipment or if the damage is due to failure to comply with the operating instructions, to carelessness, accident, incorrect use or incorrect supply voltage.

Please check our further warranty conditions and the correct procedure for a repair application on our website:

<http://www.kinematica.ch/en/contact-service/service-and-repair.html>

KINEMATICA AG reserves the right to make technical changes to the equipment without modifying equipment delivered earlier in the same way.

In the event of technical problems, for spare parts requirements or for advice, contact our regional appointed agent, your preferred dealer or us directly at:

KINEMATICA AG

Luzernerstr. 147a
CH-6014 Luzern
Switzerland

Tel. +41-41-259 65 65
Fax +41-41-259 65 75
Email service@kinematica.ch

System	POLYTRON®		
Type	PT 6100 D		
Issue	3 / 01.07.2018		
Page	33	of	33

9 DISPOSAL



The symbol of the crossed refuse container signifies that the product in the European Union to must be supplied to separate collection. Labeled products must not be disposed with household waste, rather must be left at a collection point for recycling electrical and electronic equipment. Recycling helps to reduce the consumption of raw materials and to protect the environment.